

## ALIGNMENT TEMPLATE MONTAGESCHABLONE



Inncempro BV

Lansinkesweg 4  
7553 AE Hengelo  
Nederland

Tel: +31(0)74 2501394  
Email: info@inncempro.nl  
Web: inncempro.nl

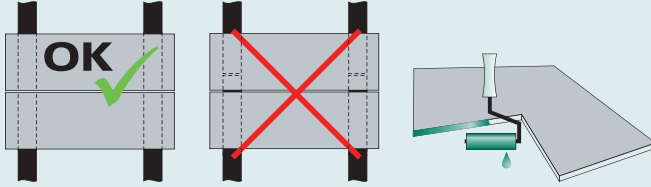

Types of screws/rivets  
Schrauben und Nietentypen

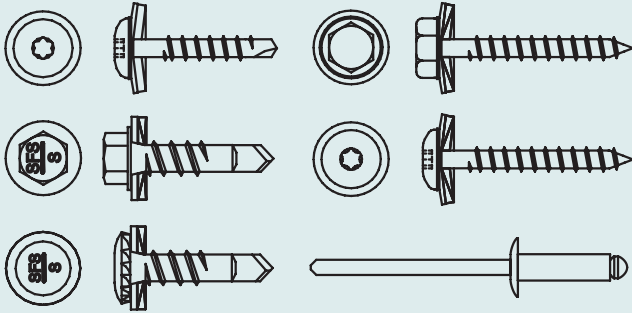

↑↑ HORIZONTAL EDGE OF THE BOARD  
HORIZONTALE PLATTENKANTE

C<sub>2</sub> 70mm

BOARD CORNER  
PLATTENECKE

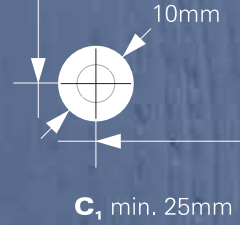

EPDM  
Rubber Tape  
Gummiband

Wood  
Holz **D**

VERTICAL EDGE OF THE BOARD  
VERTIKALE PLATTENKANTE

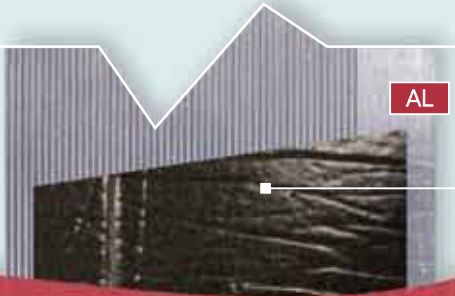

**AL**

Aluminium profile  
Aluminiumprofil

EPDM  
Rubber Tape  
Gummiband

Zinc-coated profile  
Zinkbeschichtetes Profil



**PZ**

EPDM  
Rubber Tape  
Gummiband

C<sub>1</sub> min. 50mm

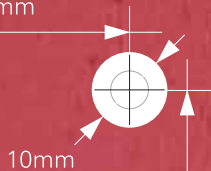

C<sub>2</sub> 70mm

↓↓ HORIZONTAL EDGE OF THE BOARD  
HORIZONTALE PLATTENKANTE

C<sub>1</sub> min. 30mm

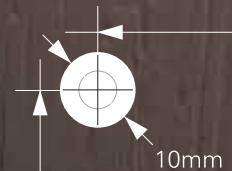

C<sub>2</sub> 70mm

BOARD CORNER  
PLATTENECKE

BOARD CORNER  
PLATTENECKE

BOARD CORNER  
PLATTENECKE

C<sub>2</sub> 70mm

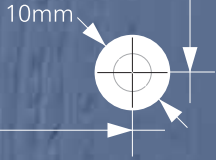

C<sub>1</sub> min. 25mm

HORIZONTAL EDGE OF THE BOARD  
HHORIZONTALE PLATTENKANTE

• PREDRILLING • VORBOHRUNG

FIXED POINT FESTPUNKT	○	∅ 5mm
FLEXIBLE POINT GLEITPUNKT	×	∅ 10mm

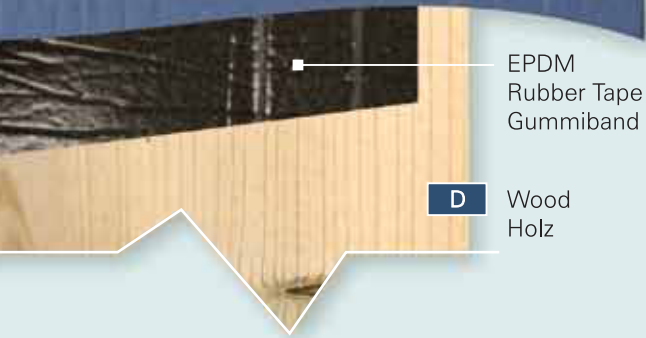
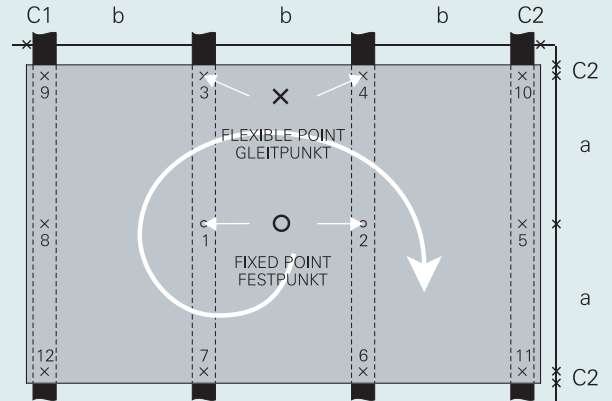

**D** Wood  
Holz

Board thickness Plattendicke (mm)	Screws/rivets spacing Schrauben/ Nietenabstand (mm)	Distance of supporting girders Stützenabstand (mm)	Dist. between the screw and the vertical edge Abstand zwischen der Schraube und der vertikalen Kante (mm)			Dist. between the screw and the horizontal edge Abstand zwischen der Schraube und der horizontalen Kante (mm)
	<b>a</b>	<b>b</b>	<b>C<sub>1</sub></b>			<b>C<sub>2</sub></b>
8	<400	<420	<b>D</b>	<b>PZ</b>	<b>AL</b>	
10	<500	<500	>25	>30	>50	>70
12	<500	<625	<50	<50	<70	<100
14	<550	<625		>50*		
16	<550	<700		<70*		
18	<550	<700				

VERTICAL EDGE OF THE BOARD  
VERTIKALE PLATTENKANTE

• Board length > 1875mm • Plattenlänge > 1875mm

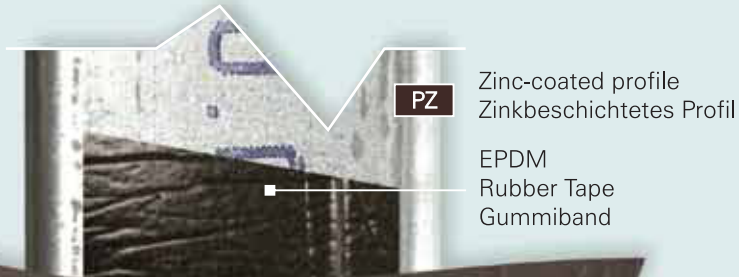

**PZ**

Zinc-coated profile  
Zinkbeschichtetes Profil

EPDM  
Rubber Tape  
Gummiband

Aluminium profile  
Aluminiumprofil

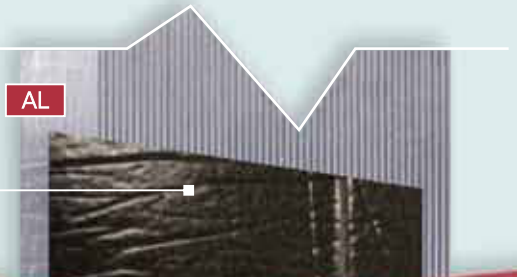

**AL**

EPDM  
Rubber Tape  
Gummiband

C<sub>1</sub> min. 30mm

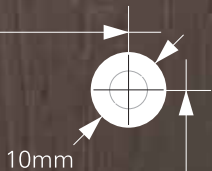

10mm

C<sub>2</sub> 70mm

HORIZONTAL EDGE OF THE BOARD  
HHORIZONTALE PLATTENKANTE

C<sub>1</sub> min. 50mm

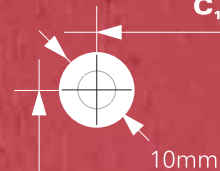

10mm

C<sub>2</sub> 70mm

BOARD CORNER  
PLATTENECKE

BOARD CORNER  
PLATTENECKE