



**SWISSPEARL
ARCHITECTURE #25**

FREE FORMS



EDITORIAL

To create unique buildings, architects sometimes experiment with free forms. Some building elements or even entire structures do not correspond with the common vocabulary of forms. Some are multiply folded, with diagonally sloping surfaces and irregular outlines. Others are rounded, corrugated, or “de-shaped” as concave, or convex. Thus arising are unprecedented building forms and façade surfaces, which deviate from convention, set themselves apart from their surroundings, and differ from the mass of structures. Christian Kerez’s project “Incidental Space” at the Venice Biennale is a current example of experimental spatial definition.

Architects develop ideas for how their building projects should look; the intended impact of the volumes and surfaces. They search together with engineers and material manufacturers for opportunities to realize their concepts of form. Sometimes existing solutions are changed, applications are varied, or new products arise. Creativity and fantasy lead to innovations in the building market and in architecture.

Swisspearl, which has processed cement and fibers with the help of other select ingredients into robust, durable products for more than one hundred years, gladly takes on the challenges of contemporary architecture. The firm upholds the tradition of developing free forms in addition to smooth and regularly corrugated panels. The so-called molding shop produces plant holders, chairs, and other accessories. For this, the technicians take advantage of the formability of the freshly mixed material. With their experience and passion they bend and pound the fiber cement into consistently new forms.

In this edition of *Swisspearl Architecture*, free architectural forms encounter the formability of fiber cement. We present custom shaped structures built at different scales and for different purposes. And we show custom formed façade claddings designed by architects and designers, and further developed by the Swisspearl staff.

We hope that you are inspired!

Michael Hanak, Editor-in-Chief

Left: “Incidental Space,” a project by Christian Kerez in the Swiss Pavilion at the 15th Architecture Biennale in Venice.

FREE FORMS

Essay by Michael Hanak

- 2 HOW FREE CAN ARCHITECTURE BE?

Interview with Professor Fabio Gramazio, ETH Zurich

- 8 DIGITAL WORLD OF FORMS

Swisspearl Summerschool 2015

- 12 ROBOTIC WIRE CUTTING

Austria: Coop Himmelb(l)au

- 16 CLOUD AND WAVE

Northern Ireland: Samuel Stevenson & Sons

- 20 BRITISH MANOR IN THE COUNTRYSIDE

Poland: Insomnia architects

- 26 A SHIP ON A SEA OF STREETS

Austria: Mang architects

- 30 WET FABRIC ON A BODY

Switzerland: Burckhardt + Partner

- 38 RAISE THE CURTAIN FOR THE MULTIPLEX CINEMA

Switzerland: Unger & Treina

- 40 BILLOWING EMBROIDERY FABRIC

Switzerland: Stutz & Kohli

- 44 DRUMLIN WITH POLYHEDRON

Italy: Studio di Architettura Franco Segre

- 50 RECLINING MONOLITH

Austria: Mathis Barz

- 54 DIAMONDS ON A FLYING CARPET

SPECIAL SELECTION

- 58 INFLATED PLACE HOLDER

PRODUCT DESIGN

- 60 SQUARING THE TABLE

AIA ARCHITECTURE CONVENTION

- 62 SHOWTOWN PHILADELPHIA

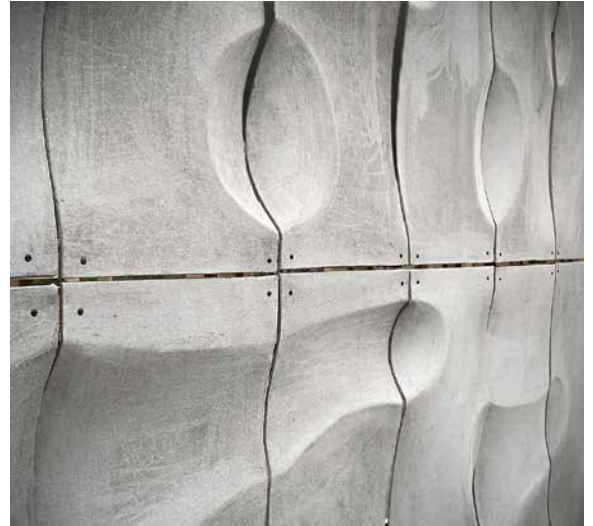

12



30



40



In architecture, digital aids make it possible to design free forms. Already in the pre-digital era, repeated efforts were made to break away from the right angle and regular geometries. Nowadays, it seems that there are no limits to imagination. All that is left to discover are the paths for implementing the ideas of form in built reality.

Many contemporary buildings have free forms. Structures are multiply bent or irregularly rounded. They have the form of irregular polyhedrons or are flowing, biomorphic shapes. Since the 1990s, free-form buildings have been grouped under the term “Blob” architecture. Sometimes there are also merely individual façade or roof areas that are undulating, jagged, or otherwise “de-formed.”

Is the intent of clients and architects to thereby rebel against the rigid geometries of the modern era? Or can the phenomenon be traced back to its technical feasibility? The fact that architects carry out the design process on a computer with corresponding software seems to be an important reason for the forms outgrowing the right angle and straight line.

Free forms in architecture also existed in the pre-digital era. Some architects departed in their designs from the right angle and regular geometries in favor of a sculptural diversity of forms. Since the early twentieth century, architects have aspired to derive the form from the conditions of function, purpose, and material, with different results. The tendency toward forms that seem to have grown from a site was identified as organic architecture. This implied, among other things, also architecture’s psychological and social utility.

A well-known example of organic architecture is the Einstein Tower near Berlin (1919–1922) built based on plans by Erich Mendelsohn, which was meant to experimentally confirm the validity of Albert Einstein’s Theory of Relativity.

Another offshoot led to the discovery of architectures with fantastical forms in the 1960s, an era of social and cultural transformation. Novel architectural ideas also found entry in other areas of life. The Japanese Metabolists developed futuristic ideas for megastructures and cities. The British architectural group Archigram searched for entirely new approaches to building and cohabitation, and offered surprising, visionary projects that took on unprecedented forms inspired by new technologies, space travel, and science fiction. Among their most renowned proposals is “Walking City,” a mobile residential structure that resembled a huge insect on metal legs. Two former Archigram members, Peter Cook and Colin Fournier, conceived the Kunsthau in Graz, which opened in 2003—a translucent, biomorphic “bubble” dubbed the “friendly alien” by its designers—as a late child of the group’s world of forms.

Deconstructionism established in the 1980s as a breaking off from the postmodern: the representatives of this architectural style dismembered and fragmented architectural bodies and re-assembled their components. Deconstructivist architecture was distinguished by a free, playful handling of architectural elements. Familiar categories such as orthogonality, sequence, and symmetry are rarely if at all

HOW FREE CAN ARCHITECTURE BE?

Essay by Michael Hanak



present, stability and balance give way to the impression of instability. One of the most recent structures by the Austrian architectural cooperative Coop Himmelb(l)au, among the most renowned representatives of deconstructivism, is the Museum of Contemporary Art & Planning Exhibition in Shenzhen, China, which opens this year. “I believe,” says co-founder Wolf D. Prix, “that it will be the first building to be built by robots, solely by robots.”

Free architectural forms are rooted also in engineering history. Originally, it was necessary to have horizontal walls or regular vaults in order to stack stones or bricks on top of one another. Since the introduction of reinforced concrete, the possibilities of formability are nearly unlimited, as long as the formwork can be produced. Computer and CAD programs ultimately expand the methods of geometric modeling in architecture, too.

Roughly twenty years ago, the computer was granted entry into architectural offices and has since become omnipresent in the infrastructure of contemporary architectural production. The first to utilize the technology were deconstructivist architects, such as Frank Gehry and Zaha Hadid, who employed software originally from the automobile industry for their designs. Today, the use of the computer and its exploitation in architectural creation has reached a new phase. Computers are no longer merely tools for drawing efficient plans; they are linked above and beyond, with the digital fabrication of building materials and components. Robots support the building process and building production.

Changing in today’s digital era, are both the idea and method of generating form. Some forms can be mastered only with a computer. Every building component produced by means of computer-controlled machines can look different. Digitally generated spatial structures challenge our imagination and open new design possibilities. Whereas previously, free form was associated with nature, intuition, and individuality—in contrast to geometric form, which embodied logics, rationality, and universality—digital free form now unites these two antithetic ideas.

Changing in today’s digital era, are both the idea and method of generating form.

Left: organic architecture in the 20th and 21st centuries. Einsteinurm in Potsdam, 1919–1922, by Erich Mendelsohn; Kunsthaus in Graz, 2001–2003, by Peter Cook and Colin Fournier; bottom station of the Nordkettenbahn in Innsbruck, 2004–2007, by Zaha Hadid; Museu de Arte Contemporânea in São Paulo, 1991–1996, by Oscar Niemeyer.



“Digital fabrication is still the exception. In the medium term, however, it will flow into all areas of architecture.”

Fabio Gramazio, ETH Zurich
(Rendering of robotically built high rises in Singapore, 2012/13)

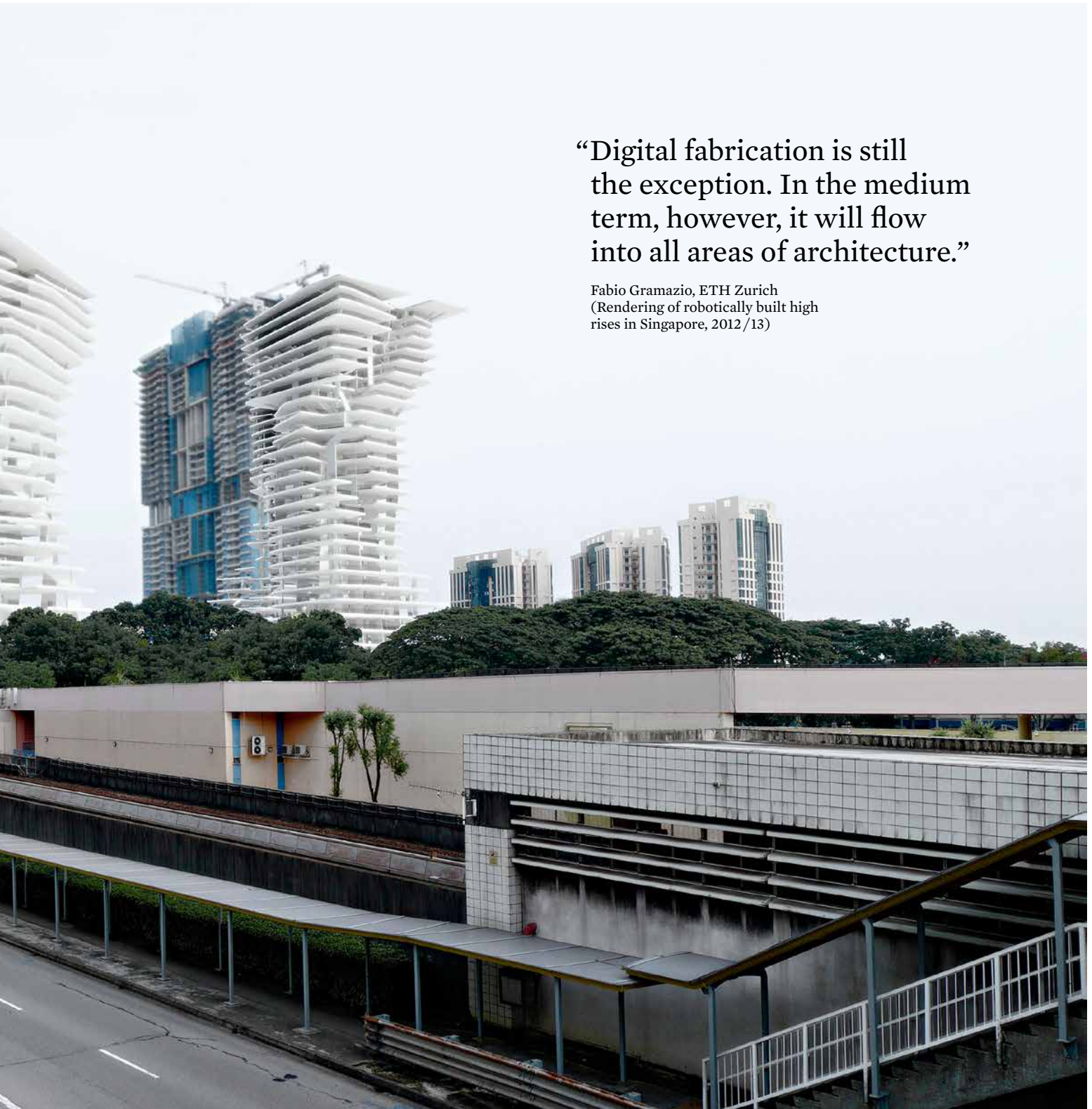

“It is about rationally manufacturing complex forms”

Interview with Professor Fabio Gramazio, ETH Zurich

Fabio Gramazio and Matthias Kohler are in charge of the professorship of Architecture and Digital Fabrication at the ETH Zurich's Department of Architecture. Research at the university ranges from building projects, such as a brick façade stacked robotically for the Weingut Gantenbein (2006), through exhibition installations, such as Flight Assembled Architecture (2011), to the design studios in which the students planned the high rises built by robots in Singapore (2011/12 and 2013/14).

Fabio Gramazio and Matthias Kohler founded their shared architectural office in 2000. Since then, they have realized a series of prize-winning buildings. Among their current works is the research and technology building “Nest” for the Swiss Federal Laboratories for Materials Science and Technology (Empa) near Zurich.

DIGITAL FABRICATION

Michael Hanak: Do free forms exist in architecture?

What do you think of when you hear this widespread buzzword?

Fabio Gramazio: A handful of well-known architects have celebrated free forms in the last twenty years. This trend coincided with the era of “star architecture” and is probably directly connected to it. The ideal that people strive for is nature, and the associated imperative for efficiency and sustainability. In na-

“Without a computer I cannot make complex forms based on multiple parameters functional. And I need the robots to transfer the complexity to the material.”

ture, there is no distinction between simple and complex forms, but instead, only sensible forms. In the world of artificial things, of manmade things, formal complexity quickly becomes very expensive. High efficiency and sustainability are—still today—usually only attainable with great expenditure. We know what would be optimal, but it costs too much to achieve it.

Frank Gehry deserves credit for having shown what is possible in terms of complexity. The Guggenheim Museum in Bilbao was the breakthrough in his career. At the same time, Gehry initiated a development in a formal and technological sense that has become indispensable. An initial obstacle was here-with surmounted. Gehry is one of the architects I admire most for the achievements that he made. His significance for the digital aspect in architecture is universally recognized today.

Digital fabrication often seems to be about controlling the manufacturing of free forms.

It is about rationally manufacturing complex forms. That includes efficiency and also control. Architecture is becoming increasingly more complex. The form is part and consequence of this complexity. The future potential is found in being able to deal with the complexity.

Can computers and robots create such complex forms that people could not design themselves?

Computers enable the designing of forms that are very elaborate to define. And when I speak of designing, what I mean is dealing with something. In the design process, the result must be sought repeatedly, until it works. Functioning can have structural, economic, or functional meanings. Without a computer I cannot make complex forms based on multiple parameters functional. And I need the robots to transfer the complexity to the material.

How free is the creation of form by means of digital aids?

There is a major misunderstanding here. Everything and nothing is free. Digital fabrication is usually about doubly curved forms. Currently, such complex surfaces are almost exclusively milled; milling is state of the art in digital fabrication, however, it is expensive and not very sustainable, as a lot of material is destroyed. 3-D printers work faster and require less material. There are several intermediate steps and hybrid forms between the

so-called subtractive and additive processes. What has to be done now is to fathom, get to know, and deploy the entirely formal repertoire of the still young technology. We architects want to find the scope within the technical possibilities in which a form makes sense and is beautiful.

What advantages does digital fabrication offer for future architects?

Digital fabrication can be a lot of things. It can also be invisible. For architects, complex forms were long outside of realm of what is possible and feasible, although there was a movement of modernism that was very expressive and organic, and ingenious thinkers, such as Frei Otto, Pier Luigi Nervi, and Antoni Gaudí created complex forms in empirical ways early on. Nowadays, everyone can draw any form with the design programs on the computer. But realizing them is another

“For architects, complex forms were long outside of the realm of what is possible and feasible, although there was a movement of modernism that was very expressive and organic.”

thing. With digital fabrication, efficient, complex forms can be realized. With the word “form,” one thinks first of all of formal questions. Digital fabrication, however, is about more than that. The reigning compulsion in the industrial era for the greatest possible repetition of the same form—whereby this repetition also presented a challenge, and led to unique aesthetics—no longer exists. Standardization is no longer necessary. The form differences between building components no longer play a role. Digital fabrication enables designing every element of a building differently, and individually. However, the fact that plotted data can be linked to the producing machines mandates that architects draw it in correspondence with the manufacturing technique. Digital fabrication is, to a certain extent, industrialized handicraft; the possibilities of the individual piece combined with the precision and manufacturing quality of an industrial process.



Fabio Gramazio (middle) with students in the workshop of Swisspearl Summerschool.

What will be the future significance of digital fabrication?

At its core, digital fabrication means linking digital drawing instruments in planning with digitally controlled machines in production. This process greatly influences architects' understanding and imagination of form.

Nowadays, digital fabrication still has a special status. In the medium term, however, it will influence all areas of architecture, as has already occurred with CAD. Some architects will create spectacular things with it, while others will use it for entirely common architecture. Digital fabrication is not a universal remedy. As architects, we have the responsibility of giving digital fabrication more than functional significance, and lending it a creative meaning.

SWISSPEARL SUMMERSCHOOL

At last year's Swisspearl Summerschool, the professorship Gramazio Kohler Research, which you head together with

“It is astounding how different the results are in formal expression. I could actually imagine every proposal as an approach to façade design.”

Matthias Kohler at the ETH, carried out a workshop. With a group of students, you examined the free creation of form with the material fiber cement. How did this come about and how did it proceed?

Swisspearl asked us if we were interested in carrying out a workshop. We saw it as a chance to investigate the possibilities of working with fiber cement. As starting point we chose a research project that was already in the final stages: a robotically operated wire cutting process that allows for the production of doubly curved cut faces.

What approach did you take to the design of the Swisspearl panels?

We purported to design panels with doubly curved surfaces. We thereby wanted to expand the functions already fulfilled by fiber cement. The realities of the material, on the one hand, and the chosen manufacturing process, on the other, limited us and defined a space for design. Despite the specified



THE PROGRAMMED WALL, 2006

If architecture's fundamental production conditions change, and digital manufacture replaces manual labor: What is the design potential for one of the oldest and most widespread architectural elements, the brick? With this question as starting point, students designed brick walls for assembly by industrial robots. In contrast to bricklayers, robots are capable of positioning each brick differently, yet exactly according to specification. Rather than defining the geometry of the wall, the students correspondingly defined the structural logics and algorithm according to which the robots would organize the material in time and space.

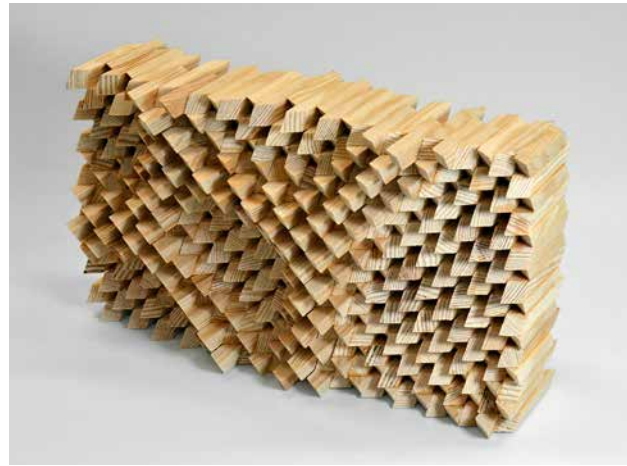

DEPTH MODULATIONS II, 2014

The robot positioned 500 individually robotically cut PVC tubes on each of four panels. The students determined the tubes' 70-millimeter diameter by considering the acoustic efficiency of the diffuse dispersion of sound waves in the human voice range. In order to make the panels even more airtight, the individual tubes were additionally internally sealed with individually positioned acrylic lids. The influence of the prototypical panels on the room acoustics could then be successfully tested in the lab.

framework conditions, a lot of methods remained that led to extremely diverse results.

Among the results presented, I discovered mainly wave and cavity forms. Why is that?

A hanging wire makes the robotically controlled cutting process unique. In the study, we wanted to work out which forms are possible with this process. Covering the Styrofoam surfaces cut in this way with fiber cement is not so easy. The raw, still soft material can be smoothed in only to a certain extent. The correct handling of the fiber cement requires technical know-how. The idea was to combine the possibilities of the process with the formability of the material. The designs arose from both the technology and the material's qualities.

What limits did you experience in molding the fiber cement?

The radius of the curves cannot be randomly small, at some point the fiber cement tears.

We approached this border empirically. The students quickly learned to grasp the qualities of the material. We were amazed at what can be created when you know how. That was part of the process of gathering experience.

How do you judge the results of the workshop?

It is astounding how different the results are in formal expression. I could actually imagine every proposal as an approach to façade design. The goal of the workshop was to show how great the scope of possibility is. In this context, it can obviously not be about developing a product.

What are the chances of a realization in actual practice?

Developing a marketable product would be the next logical step. That is an entrepreneurial decision. In the building industry, investments have to be thoroughly considered. Studies, market analysis, pilot projects, and so forth, are necessary. But the possibilities of

mobile, shaped, fiber cement panels have been recognized, and I think that in the long term this will most definitely bear fruit.

Literature

Fabio Gramazio, Matthias Kohler (eds.), *Made by Robots. Challenging Architecture at the Large Scale*, London: Wiley, 2014.

Fabio Gramazio, Matthias Kohler, Jan Willmann (eds.), *The Robotic Touch. How Robots Change Architecture*, Zurich: Park Books, 2014.

Fabio Gramazio, Matthias Kohler, Silke Langenberg (eds.), *Fabricate: Negotiating Design & Making*, Zurich: gta Verlag, 2014.



EXTRUDED STRUCTURES, 2015

Students examined the design and the manufacture of robotically printed three-dimensional frame structures. Serving as an initial starting point were common triangulated systems. Subsequently, geometrically sophisticated frames made from ABS synthetics were realized as continuous extruded structures. Additionally employed were a universal robot UR5 robotic arm and a custom built material extruder. The students also examined how to create three-dimensional space frameworks, complex protrusions, and superstructures as well as free-form floor attachments.



SPATIAL WIRE CUTTING, 2015

Students examined the architectural potential of a robot-supported spatial wire-cutting process. This technique enables the efficient production of geometrically complex architectural elements. With repeated computer-supported simulations and robot-supported manufacture, they developed various typologies of non-standard geometries and examined their structural possibilities by uniting larger structures. The students generated and articulated their designs by means of two robotic arms that control the path curve of the hot wire and produce material-physical prototypes.

SWISSPEARL SUMMERSCHOOL 2015

ROBOTIC WIRE CUTTING

In September 2015, Swisspearl invited professors Fabio Gramazio and Matthias Kohler to carry out the Swisspearl Summerschool together with the students. The professorship of Gramazio Kohler Research at ETH Zurich has been concerned with digital fabrication in architecture since 2005, and founded the world's first robotics lab for non-standardized fabrication processes in an architectural context. This opened up an entirely new research area. Swisspearl has long been involved in the education and promotion of young architects and almost every two years since 2011 has carried out a two-week Summerschool focusing on topical, architecturally relevant issues. At the 2015 Summerschool, the goal was to examine the architectural potential of a robotically controlled spatial wire cutting process.

For the "Robotic Wire Cutting" workshop, the students developed designs and with the help of programmed robots cut three-dimensional molds out of polystyrene blocks. Serving as cutting instrument was a hot wire, led on each end by a robotics arm, and shaped by the resistance of the polystyrene. This path curve made of wire changes continually during the cutting process. The molds thus produced, formed the basis for manufacturing fiber cement panels in a desired form: the cut polystyrene was later laminated with a layer of fiber cement. In the molding shop of the factory in Payerne, the experts familiarized the students with the conditions and tricks for molding fiber cement. Finally, the workshop participants used the self-

fabricated panels to assemble prototypes for façade walls. Depending on the students' developed method, the material appeared at times solid and hard, at times filigree and soft.

The results reflect the forms possible when using a particular process and show the degree of complexity enabled by digital fabrication. The Swisspearl Summerschool 2015 students thus acquired valuable knowledge about both digital fabrication and how to deal specifically with a building material. Those responsible for the project are extremely pleased with what was accomplished. David Jenny, who supervised the students on site, found the change from one material system to another extremely exciting: "By combining the digital, robotic cutting of polystyrene with the hand molding of fiber cement, we can manufacture novel façade panels. The Swisspearl Summerschool has shown us entirely new possibilities for both processes." The results were filmed and publicly exhibited at the Architekturforum Zürich.

Credits

Gramazio Kohler Research, ETH Zürich: Fabio Gramazio, Matthias Kohler, David Jenny (project director), Romana Rust (research director)
 Students: Sarah Barras, Li Bo, Marco Caprani, James Chenault, Ahmed Elshafei, Victoria Fard, Alix Gasser, Aurèle Gheyselinck, Ana Grgurac, Marco Palma, Julien Prudhomme, Ludwig Schilling, Stavroula Tsafou, Stéphane de Weck
 Expert: Marco Ganz
 Guest critics: Matthias Rippmann, Asbjørn Søndergaard









AUSTRIA

CLOUD AND WAVE

Martin Luther Church, Hainburg an der Donau

LOCATION: Hainburg an der Donau CLIENT: Association "Freunde der Evangelischen Kirche" in Hainburg/Donau

ARCHITECTS: Coop Himmelb(l)au, Wolf D. Prix/W. Dreibholz & Partner GmbH, Vienna

(PROJECT ARCHITECT: Martin Mostböck, DESIGN ARCHITECT: Sophie-Charlotte Grell) BUILDING PERIOD: 2008–2011

STRUCTURAL STEEL FAÇADE: Metallbau Eybel, Wolfsthal FAÇADE CONSTRUCTION: SFK GmbH, Kirchham

Other than the expressive bell tower, the most noticeable feature of the evangelical Martin Luther Church is a cloud that sinks gently onto the structure. Folded glass elements reminiscent of a crystal organize the building volume. Wavelike patterns are milled into the Swisspearl façade panels.

RAHEL HARTMANN SCHWEIZER "Would now the wind but had a body." Architect Wolf D. Prix virtually raves about this line from *Moby Dick*—most recently when presenting the project for the Munich Opera Festival's temporary venue, which opened in June 2010. The building does, after all, recall a cluster of sails torn to tatters by the wind. BMW Welt—the exhibition, delivery, experience, and museum complex, which Prix and his office completed in 2007—has even been associated with a tornado.

Ever since founding the architectural studio Coop Himmelb(l)au in 1968 together with Helmut Swiczinsky and Michael Holzer, the architect has been fascinated by the absence of gravity. The three set out to turn traditional architecture upside down and annul gravity: "Coop Himmelb(l)au is not a color, but an idea, of creating architecture with fantasy, as buoyant and variable as clouds." In doing so, the architects did not toss either context or traditional architecture to the wind: not that of pre-1900 and not the meanwhile canonic twentieth-century architecture.

They present this exemplarily with the church in Hainburg an der Donau—the town where Prix was born—which is located on the precise spot where a house of prayer had stood until the seventeenth century. The roof makes reference to the neighboring Roman

ossuary from whose concave tent-shaped roof Coop Himmelb(l)au developed the geometry of the hood, as well as to Le Corbusier's chapel of Notre Dame du Haut in Ronchamp and his Convent Sainte-Marie de La Tourette in Éveux. While the chapel in Ronchamp is associated with structures such as a ship, a bunker, or a cloud, the roof in Hainburg combines the airy optics of a cloud with a ship's technical production; the roof was, namely, produced in a shipyard.

The cone-like structures in the chapel of La Tourette that stretch into the sky as "light cannons" are the reference for the three skylights in Hainburg. The tapered geometry, in multiple variations, is meanwhile part of Coop Himmelb(l)au's canon of forms. In Hainburg, it seems to develop from a single movement. Yet what seems to have been produced from a single cast comprises 264 soldered tin panels. Together with the primary and secondary frames they serve as compression chords, while the rolled-steel joists attached to the frame take over the part of tension booms. The entire sheet metal shell is integral to the load-bearing structure.

Crystalline element

Consorting with the cloud is the crystal. Crystal and cloud were already the two formative symbols for Musée des Confluences in Lyon. In Hainburg, the folded protruding and recessed glass façade now functions as the crystalline element. It opens the worship space towards the street. The third element is provided by the closed façade surfaces clad in fiber cement panels. Meandering across the earth-toned cladding are patterns, such as those drawn by waves in the sand. This changeable image contrasts the solid façade

panel. The panel is a new development, whose prototype was applied in Hainburg. In order to achieve the three-dimensional relief of the surface, Swisspearl employees milled the undulating lines into the fiber cement panels after the hardening process.

Once on the track of Moby Dick, the temptation is great to leaf through a few more pages in his story: "Wave after wave thus leaps ..."

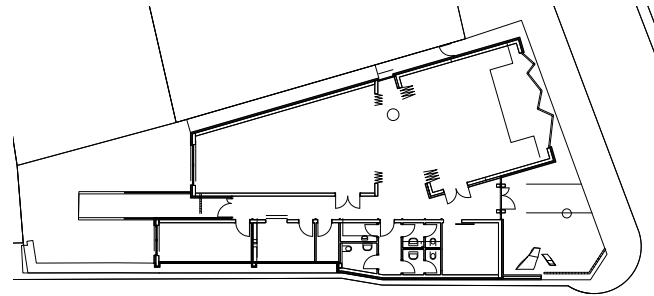
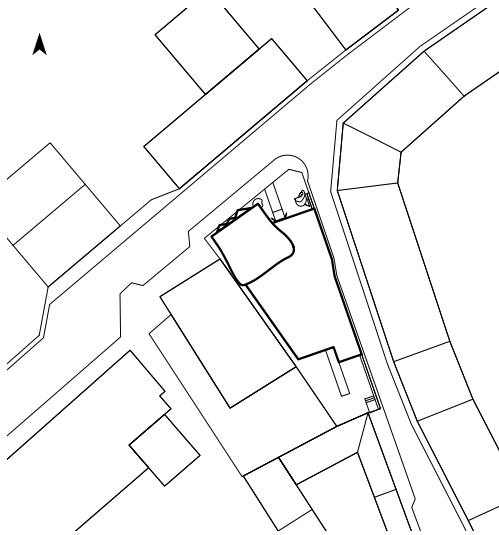

First floor 1:500

“Would now the wind
but had a body.”

From: Herman Melville, *Moby Dick*, 1851

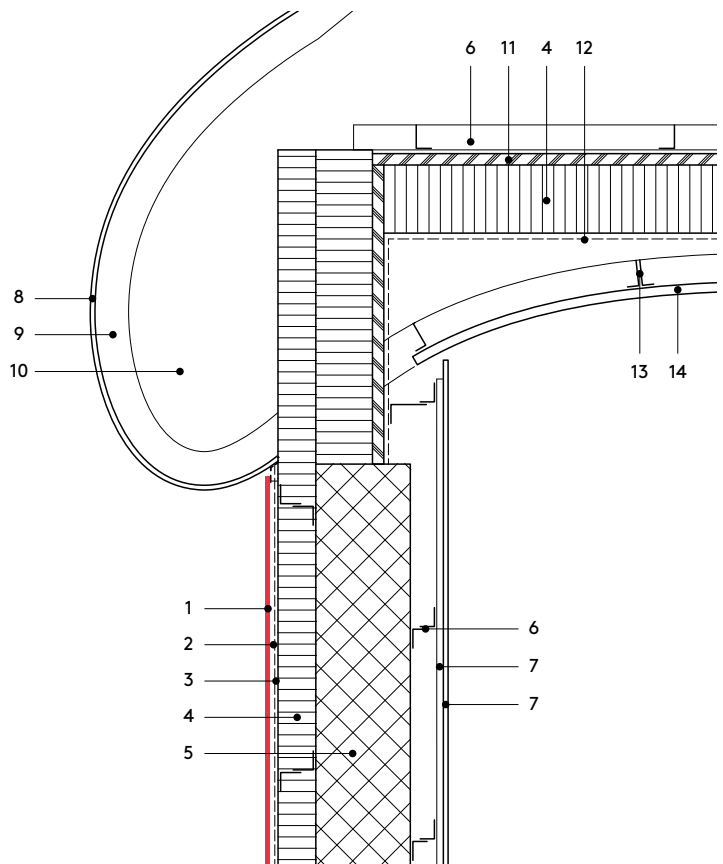

Vertical section 1:20

- 1 Swisspearl® LARGO, 12 mm, milled relief
- 2 ventilation cavity, vertical sub framing
- 3 moisture barrier
- 4 thermal insulation, mineral wool
- 5 concrete
- 6 structural steel
- 7 gypsum plaster board
- 8 steel sheet
- 9 steel frame
- 10 rear-ventilated attic
- 11 chip board
- 12 vapor retarder
- 13 suspended structural steel
- 14 plaster

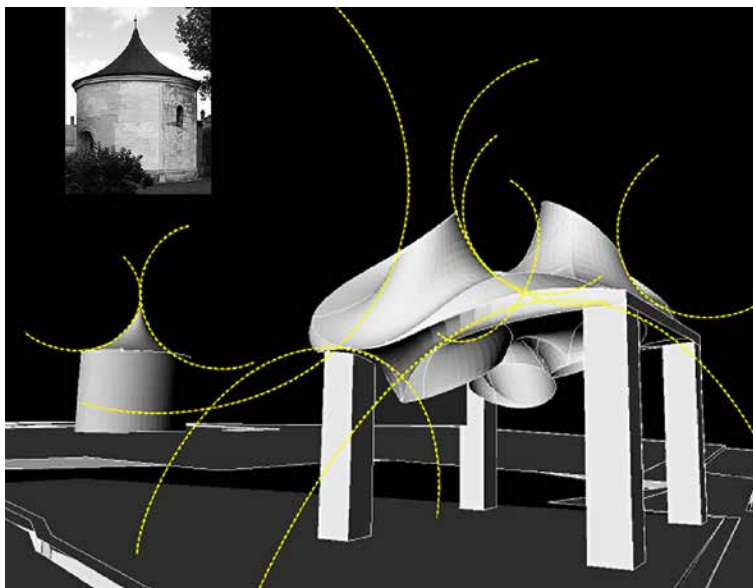

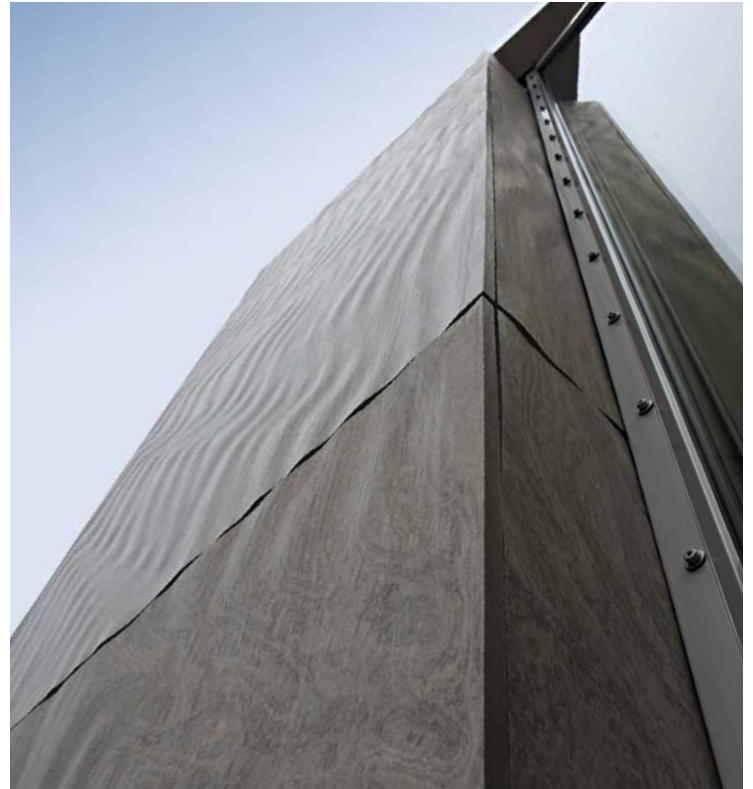
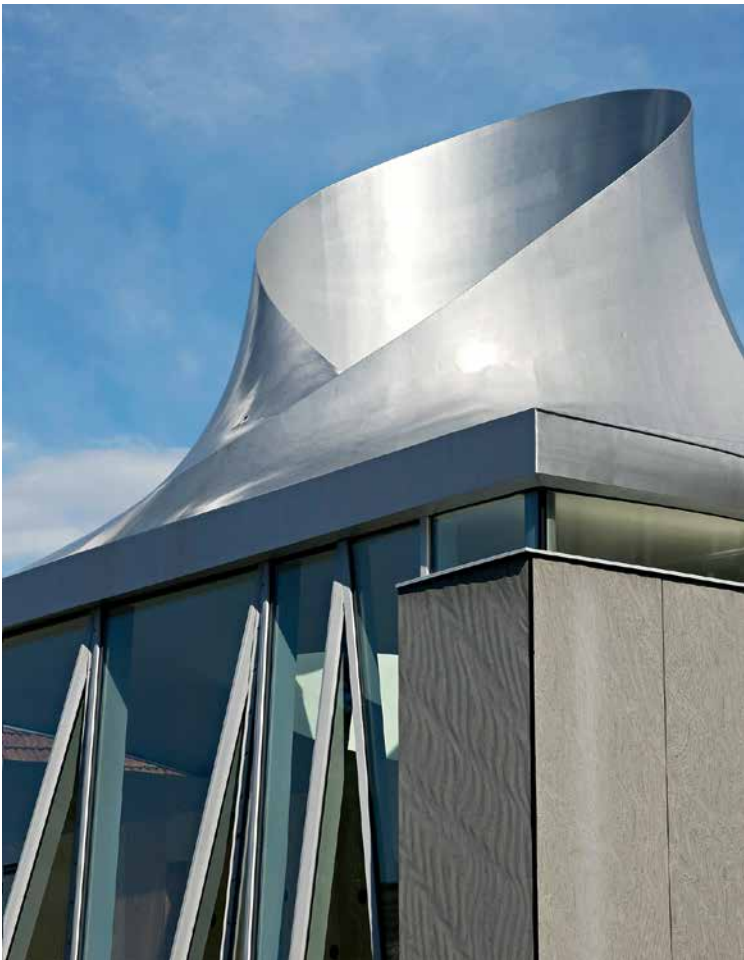

Traces of waves in the sand: For the relief, undulating lines were milled into the fiber cement panels after the solidifying process.



NORTHERN IRELAND, UK
BRITISH MANOR
IN THE COUNTRYSIDE

Foyle Arena, Derry/Londonderry

LOCATION: Limavady Road CLIENT City of Derry and City Council of Strabane
ARCHITECTS: Samuel Stevenson & Sons, Belfast (PROJECT ARCHITECTS: Gerard Scullion, Peter Niblock)
BUILDING PERIOD: 2013–2015 GENERAL CONTRACTOR: O'Hare & McGovern Ltd, Newry
FAÇADE CONSTRUCTION: Edgeline Metal Roofing Ltd, Magherafelt



The replacement building for a sports center that had seen better days marks the entry to a sweeping park in Derry/Londonderry. The architects arranged three decisive functions along a central axis and subtly differentiated them in their architectural expression: the façade skin combines zinc, wood, and light-permeable panels with Swisspearl panels in three different tones of gray.

PATRICK ZAMARIÀN In the city of Derry/Londonderry in Northern Ireland, near the border to Ireland, the bloody battles between Protestant Loyalists and Catholic Republicans began in the late 1960s. The conflict, which is reflected until today in disagreement on the name of the town, paralyzed development for decades. However, a certain sense of revolt has reigned since 2010, when the town became the first British cultural capital, as a result of which, the city council pushed forth prestige projects, such as the Peace Bridge over the Foyle River. This is also evident in the Foyle Arena, which the architectural office Samuel Stevenson and Sons built in the popular St Columb's Park in the city center.

With a multifunctional sports complex, the dimensions of the spatial program are largely pre-set, which means that the freedom in terms of design in articulating them

is highly restricted. The challenge for the architects comprised combining the spatial components, which in the Foyle Arena are a climbing hall, a double indoor swimming pool, and a multipurpose hall, to a coherent unit and assuring that visitors find their way in the large complex.

The architects of the Foyle Arena divided the layout into three parallel spatial levels running in a north-south direction. Along the central axis are the fifteen-meter-high climbing hall, which is also sunk three meters into the ground, as well as various gyms and fitness rooms in the back-facing areas of the building and on the upper floor. The two swimming pools are found in the western part of the complex; the eastern part accommodates a judo hall and a multipurpose gymnasium, which thanks to the support-free construction can be combined to form an

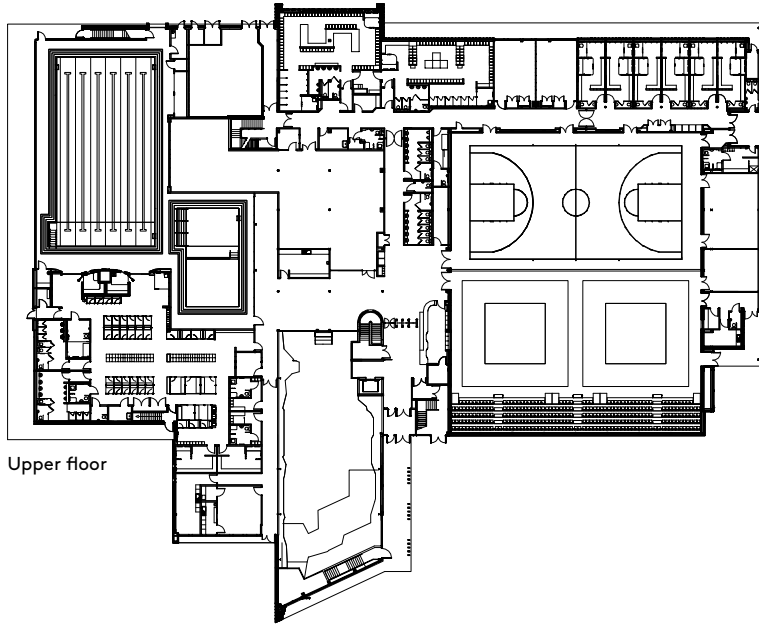

Upper floor

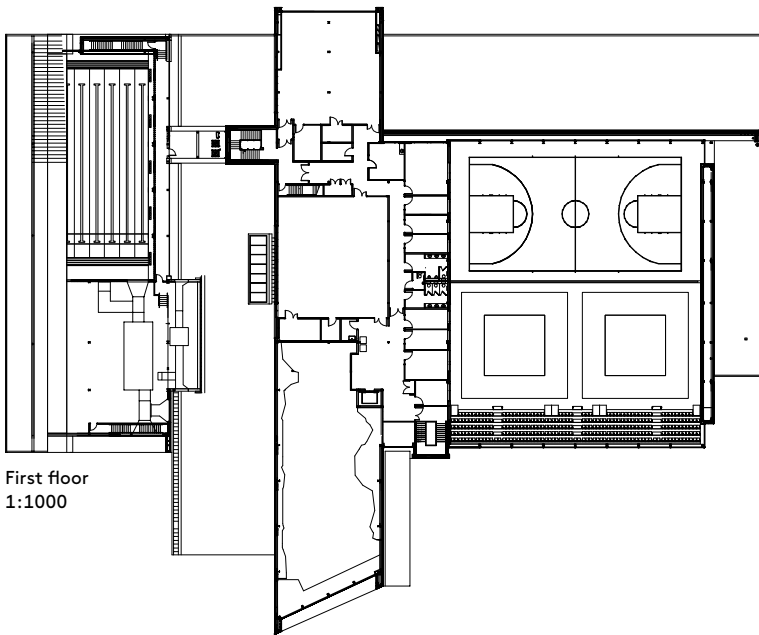

First floor
1:1000

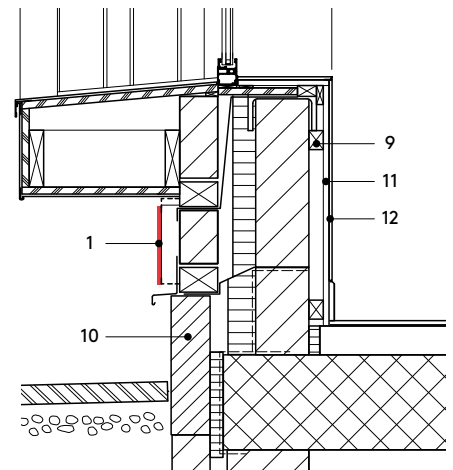
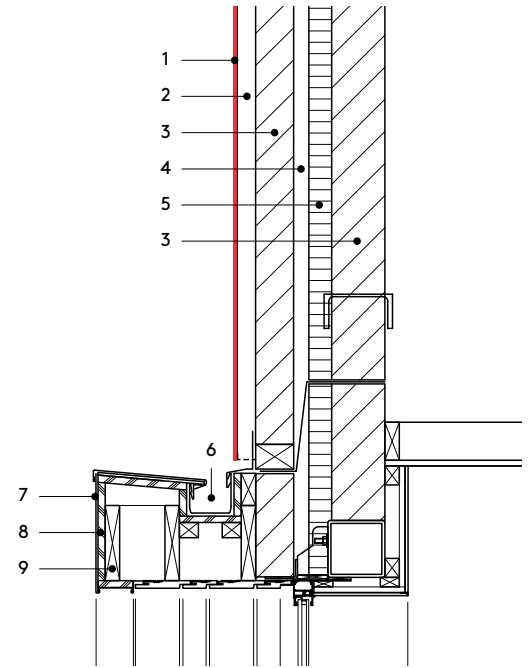
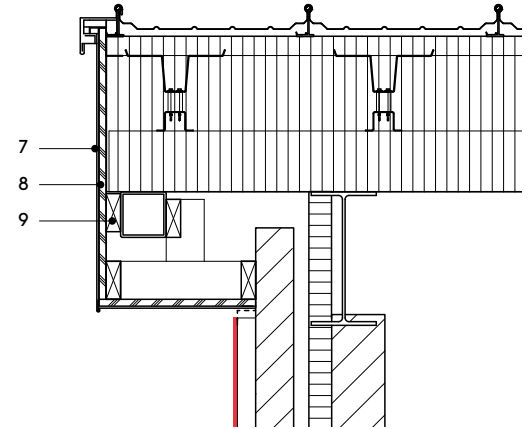

Vertical section 1:20

- 1 Swisspearl® LARGO, 8 mm
CARAT Crystal 7010, Black Opal 7021,
Agate 7219
- 2 ventilation cavity, vertical slats
- 3 brickwork
- 4 ventilation cavity
- 5 thermal insulation
- 6 water gutter
- 7 metal sheet
- 8 plywood board
- 9 batten
- 10 facing brick
- 11 gypsum board
- 12 wall cladding

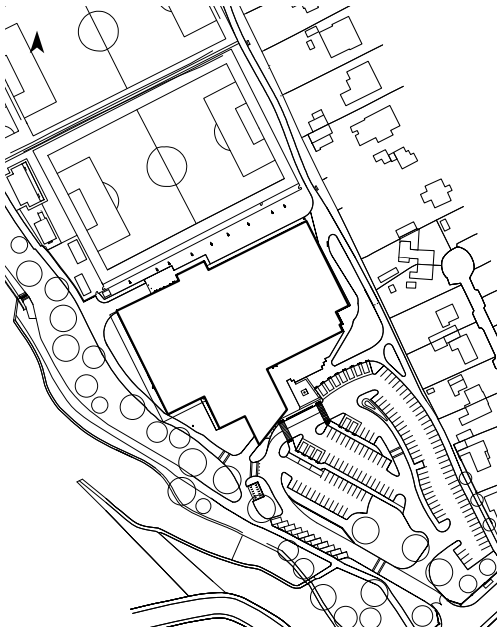

“It is a conscious intention of the design, to familiarize approaching visitors with the function of the building and to support this wherever possible with the use of transparent areas.”

Samuel Stevenson & Sons architects

events hall for 2,000 visitors. The main access leads between the climbing hall and the east wing to a central foyer from where the visitors have an overview of all three building sections.

An archetype for the central building

From outside, the axial structure can be read in the building's tripartite design. The complex's eye-catching feature is the climbing hall, which as an entirely glazed, far protruding central projection marks the main entrance and produces a symmetry-like hierarchical relationship between the western and eastern building parts. In terms of form, the central building makes use of an archetype so that from a distance, it is reminiscent of a British manor house embedded in an overhanging landscape garden. This picture is underscored by a private access road with a cast-iron gate welcoming visitors at the turnoff from the main road. The road separates the main face from the parking spaces. Also the north façade, which turns toward the adjacent outdoor playing fields and the park sloping downward to the river, is formulated in a similar way despite a different spatial configuration, and underscores the building typology.

The façades of the Foyle Arena are kept in a collage-like juxtaposition, contrasting in terms of color as well as material, as is omnipresent in contemporary British architecture. The most remarkable design feature is the double-layered zinc façade, which frames the central building volumes, continues as a roof over the swimming pool, and with its layered, rolling form, evokes the image of waves. Serving as bracing is extensive glass, in part coated with green film, as well as Swisspearl panels in three different gray tones.

The architects pursued an entirely different design approach with the orthogonal multipurpose hall, where they decided to forego a demonstrative gesture with the roof. In the upper area of the side façade they again combined Swisspearl panels in various gray tones; for the longitudinal façade, they chose, in contrast, a system of translucent panels, which direct natural light into the interior. On the ground floor, a continuous horizontal row of windows runs above a wood-clad base, behind which are offices, cloak rooms, and other secondary spaces, like in the west wing.

A particularly successful application of the Swisspearl panels found on all facades is in the entrance area, where the outwardly folded zinc façade of the climbing hall shapes

a covered entryway. The restrained coloring and precise panel alignment form a stylish background for the wood-covered steel supports, which in their formal design recall the Arts and Crafts tradition and thus underscore the new sports center's "British-ness."

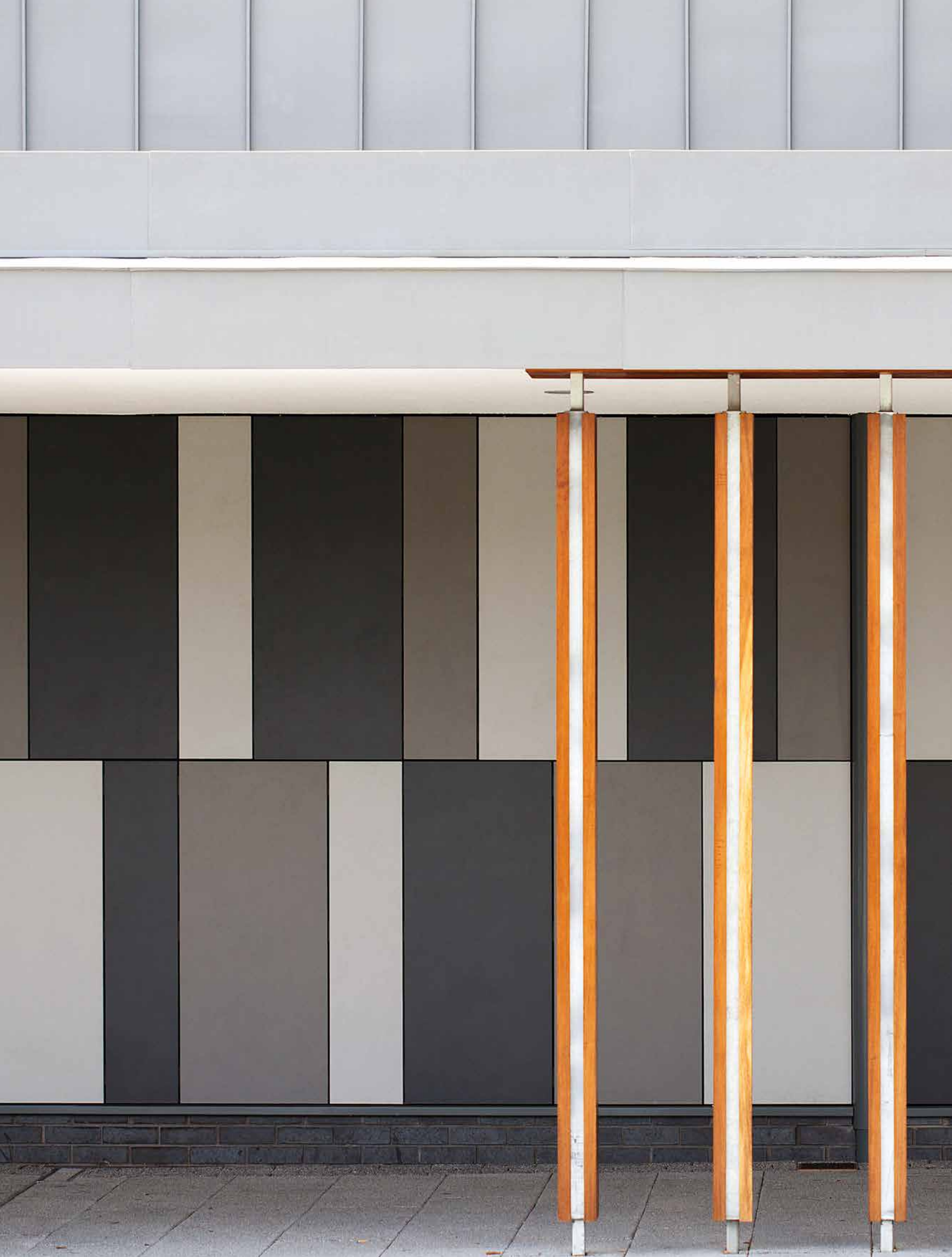



Swisspearl panels in three different gray tones flank the entryway. The formal design of the wood-coated steel columns borrows from the British Arts and Crafts tradition.



POLAND

A SHIP ON A SEA OF STREETS

Jet Office, Poznan

LOCATION: ul. Piątkowska 163, Jeżyce CLIENT: PPHU Masterm, Tarnowo Podgórne, Poznań

ARCHITECTS: Insomnia, Poznań (PROJECT ARCHITECTS: Szymon Januszewski, Agnieszka Liguz, Juliusz Dudniczek, Marta Gasiorek, and Marcin Całka) BUILDING PERIOD: 2011/12

GENERAL CONTRACTOR: PPHU Masterm, Tarnowo Podgórne, Poznań

FAÇADE CONSTRUCTION: Greškiewicz PHU, Bydgoszcz

The spectacular office building in Poznan is located on a plot that remains between tramway tracks and two main transport axes. The structure's wedge-shaped volume ensues from the property's triangular area. Black Swisspearl panels comprise the façade skin, which is structured by vertical, shading blinds.

PATRICK ZAMARIÀN Poznan is located halfway between Warsaw and Berlin in one of Poland's most densely settled metropolitan areas. The city has a long history as a trade center and thanks to excellent transport connections, has reaped the greatest benefits from the country's European integration. Over the past several years, numerous national and international firms have settled in Poznan; therefore, there is great demand for office space and high pressure on developers to make a mark architecturally and thereby distinguish themselves from competitors.

Triangular plot

A particularly sensational example of this is the Jet Office building, which the local architectural office Insomnia built at the intersection of two main transport axes in the north of the city. Access to the building occurs via a secondary road on the west side, which separates the triangular plot from the tramway tracks and a green space behind. The spatial program comprises an underground parking garage, a shop level oriented toward the east facing busy Piatkowska street, and 1,900 square meters of office space distributed across three complete floors and a fully glazed, recessed loft level.

The plot's unique shape demanded a special approach to design in order to optimally utilize floor areas. Normally, office buildings have a central access core and a regular support grid offset from the exterior walls to assure maximum flexibility in the distribution of spaces and façades. However, apart from one single internal row of supports, the reinforced concrete structure of the Jet Office is arranged peripherally. The same applies to the reinforced core executed in exposed con-

crete, which alongside the elevator and stairway, contains the communal toilet facilities, and makes different zoning in the office areas possible by means of separate entrances.

Making a virtue of necessity

Whereas the layout made spatial planning more difficult, the architects made the best possible use of it in the outer form. They even exaggerated the "pointed" staging of the three-cornered plot. With the exception of the development core on the backside and the adjacent wall area, the entire building volume is cloaked in a façade shell of black fiber cement panels and given rhythm by vertical blinds. The recess of the main façade takes on the alignment of the building bordering to the south; towards the north, the building effectively culminates in a cantilevered corner situation reminiscent of a ship's bow. The nautical connotations are entirely intentional—here as well as there, the architects argue for the dynamic form primarily with functional rather than formal considerations.

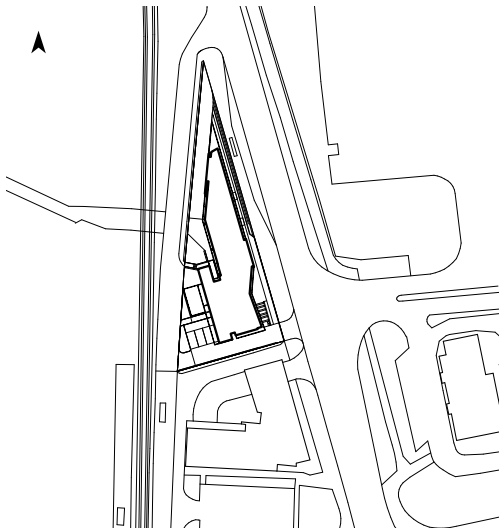





“The main reason for the building’s unusual form was the tightly bordered and triangular plot of land.”

Insomnia architects

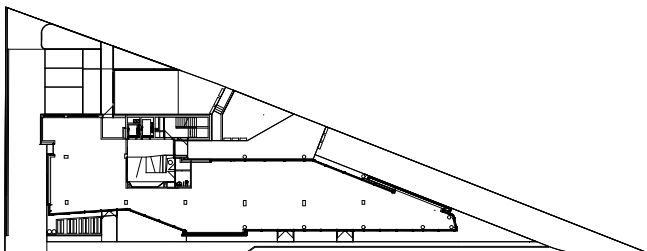

First floor 1:1000

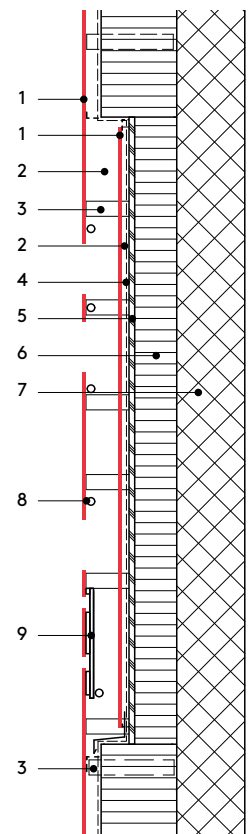

Vertical section 1:20

- 1 Swisspearl® LARGO, 8 mm REFLEX Black Velvet 9221
- 2 ventilation cavity
- 3 bracket
- 4 moisture barrier
- 5 plywood board
- 6 thermal insulation, mineral wool
- 7 concrete
- 8 backlit lettering
- 9 acrylic glass, colored





AUSTRIA
WET FABRIC ON A BODY

Spar Supermarket, Alland

LOCATION: Mayerlinger Strasse 4 CLIENT: Spar Österreichische Warenhandels AG, Salzburg
ARCHITECTS: Mang Architekten, Furth-Palt DESIGN FIBER CEMENT PANELS: Eva Manhart and Philipp Ehfrank
BUILDING PERIOD: 2015 GENERAL CONTRACTOR: Swietelsky Baugesellschaft GmbH, Feldkirch
FAÇADE CONSTRUCTION: SH Systembau GmbH, Scheiffling



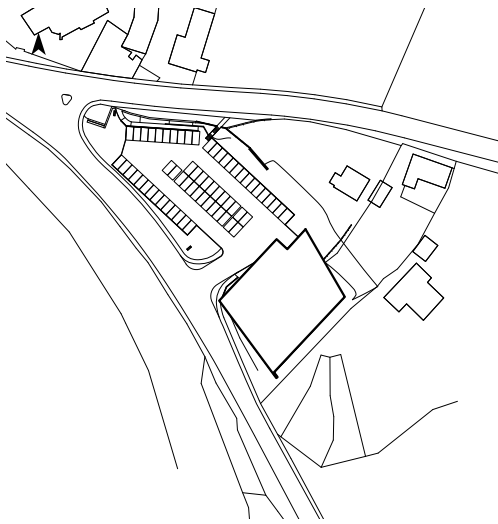

For two students from the Vienna University of Technology, the dream of every design student came true: the architect planning the Spar Supermarket in Alland discovered their prototype for a three-dimensional façade panel that undulates like wet fabric. The bespoke shell lends the new construction a striking appearance.

ANNA ROOS What limits are there to the shaping of fiber cement? Design students at the Vienna University of Technology grappled with this question in the summer semester 2013. Their task was to develop a system that can wrap around or cover a space or object comprising separate elements.

To conclude the semester, the students traveled to the Swisspearl factory in Vöcklabruck near Salzburg and together with experts developed prototypes of their designs. Two of the students, Eva Manhart and Philipp Ehfrank, wanted to emphasize fiber cement as a material, as Ehfrank explains, whilst “make it appear lighter and more fabric-like.” And, as Manhart adds, “Also introduce a certain elegance.” Serving as model for their design was a large piece of fabric that the two designers intuitively draped. They shaped and modeled the material while damp in order to reproduce the folds of fabric in the fiber cement. For their façade system, they developed eight different prototypes that can be mounted either horizontally or vertically.



The two emerging designers were given positive feedback at the final presentation. Still, neither they nor Swisspearl counted on a company selecting their design for realization so soon after its development.

Tailored façade emphasizes expressive roof form

The supermarket chain Spar planned a new branch in a prominent spot in the small village of Alland, roughly forty kilometers south of Vienna: within sight of the church, on a site that has good connections to the local infrastructure, at a local transport node. A new supermarket would upgrade the hitherto unused square and replace an existing structure. The architectural expression of the new building was important for creating a landmark at the highly visible location. Architect Christian Mang’s concept foresaw lending the building a strong concept with an innovative, three-dimensional façade. When he discovered Manhart’s and Ehfrank’s prototype, Mang says, “I was immediately con-



vinced that it was the right cladding material for our Spar project. It fit to our design.” He was impressed by the large, sculptural surfaces of the panels. The three-dimensional façade would likewise highlight the dynamic effect of the deeply cantilevered roof.

The inquiry from Spar caused a few moments of concern in Vöcklabruck. Molding a material three-dimensionally for a prototype is relatively simple, explains product manager Christoph Pohn. However, standardizing the panels for an effective structure and manufacturing them precisely is quite a challenge. It took roughly one-year’s time before Manhart’s and Ehfrank’s prototypes were ready for serial production and the panels could be produced for the supermarket’s façade. In doing so, damp fiber cement plates were laid on the various wooden models and subsequently smoothed into the folds and bulges by hand.

The fiber cement panels drape the façade of the supermarket like wet fabric. As though wanting to recall the damp, moldable state

in the formation of the panels, the surface structure in muted gray stirs the impression of a soft, sculptural material. The horizontal and vertical fissures between the panels provide a visual counterbalance to the waves. In addition to the façade, the building’s other distinguishing feature is a deeply cantilevered roof. Smooth Swisspearl panels in the same gray tone as the façade elements were used for the underside of the cantilever.

The daring and dynamic impression given by the façade lends the building a striking character. The budding designer Eva Manhart found it “pretty cool” to see the piece of fabric she and Philipp Ehfrank had draped at the start of their design process, now hanging on a façade in an almost exact copy made of fiber cement.



Two Vienna University of Technology students, Eva Manhart and Philipp Ehfrank, experiment with damp fiber cement.

The Swisspearl employees print and smooth the fiber cement panels in the folds and elevations of the model by hand.

An entirely undulating surface arises from eight different panel forms.





“We wanted to make the material fiber cement appear lighter and more fabric like. And also, bring in a certain elegance.”

Eva Manhart and Philipp Ehfrank, designers

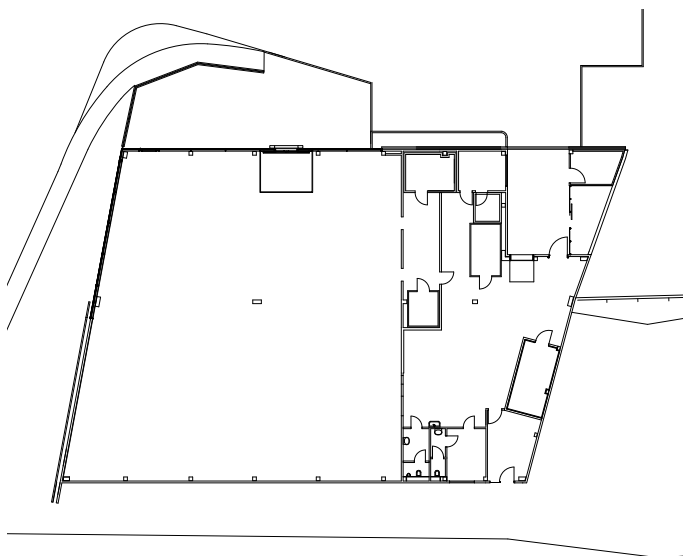

First floor 1:500

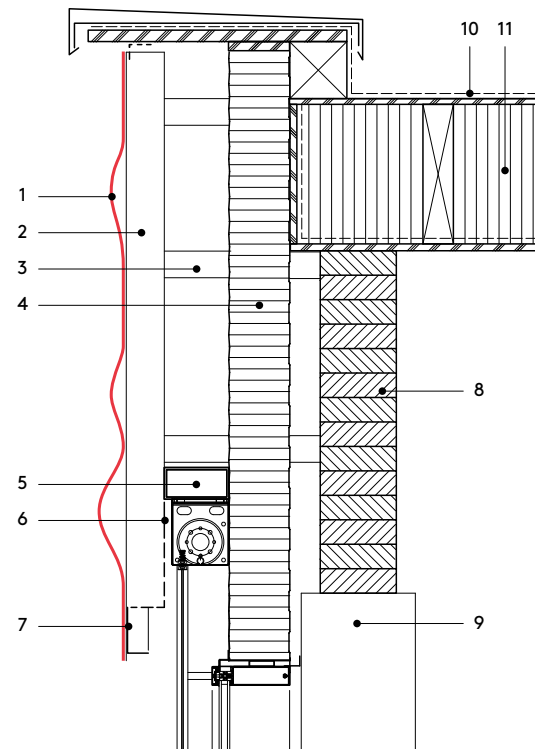

Vertical section 1:20

- 1 Swisspearl® 3 D panel, 8 mm, individual construction
- 2 ventilation cavity, aluminum sub framing
- 3 bracket
- 4 thermal insulation, sandwich panel
- 5 steel beam
- 6 insect screen
- 7 sub framing
- 8 glulam beam
- 9 concrete support
- 10 waterproofing
- 11 timber roof panel



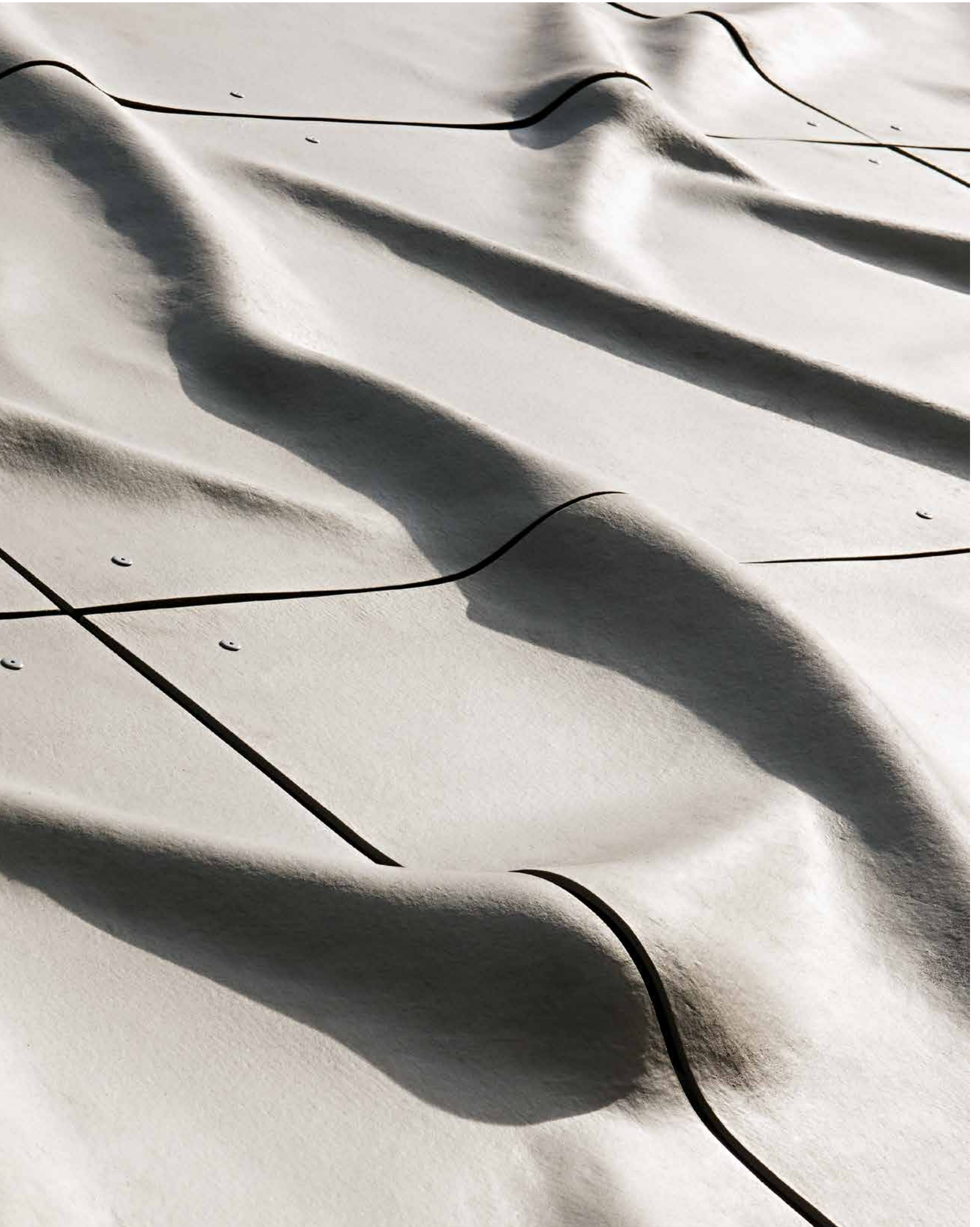



SWITZERLAND

RAISE THE CURTAIN FOR THE MULTIPLEX CINEMA

When the leisure center of the Mall of Switzerland opens its doors in fall of 2017, the façade should ripple and swell around it like a theater curtain. For this image, the architects and Swisspearl professionals have to master various technological and manual challenges.

RAHEL HARTMANN SCHWEIZER How can one lend a face to the exterior of a building that should not be looked into or out of? For the leisure center with movie theater in Ebikon, the architects from Buerkhardt and Partner and tgs Architekten took on a motif that captures the moment of tension when the curtain is opened in a traditional movie theater. The façade is meant to swing around the structure like fabric that juts forward and back.

The Kantonsstrasse along the highway A14, which connects Zug with Lucerne, appears in part as a small-format “Las Vegas Strip.” The Mall of Switzerland is meant to reign in the uncontrolled development area by means of two urban structures. This should occur on a 73,000 square-meter plot, a no longer required land reserve of the ele-

vator and escalator firm Schindler. In addition to a shopping center with 46,000 square-meter retail space for roughly 150 shops and restaurants, the architects are planning, under commission from the project developer, a leisure center with multiplex cinema.

Complex sensuality

The answer to the desire for a curtain-look was corrugated panel. But the architects were looking for a shape that “copied” the model more precisely. Thus, the swings should occur just as irregularly as those in the heavy velvet panels in the theater. Apart from that, they wanted a more distinctive forming of the waves’ peaks and valleys, that is, height differences of approximately thirty centimeters, far surpassing the 5.2-centimeter difference in the corrugated panel.

These ideas confronted the Swisspearl factory in Payerne with what was literally a make-or-break test. The radius of the waves could not be too narrow, nor the difference between height and depth too large. The former would lead to tears in the fiber cement, and with 125-centimeter long material, the

latter to merely one wave per panel. In the end, the maximum height difference could be established at fifteen centimeters.

The anthracite-colored mock-up shows one of four possible variants. In the end, two different shapes were designed, which can each be turned 180 degrees. This lends additional dynamics to the rhythm of the waves.

In addition to the technological and manual challenges was that of the deadline. In order to assure delivery within the allotted time, it was necessary to pour several empty molds—taking into consideration the drying time of two days for each panel. Additionally, a new fastening system was required as the experts anticipated stronger dilation than with “classical” Swisspearl panels.



The pattern shows the impressive “topography” of the element. The wave valleys must be so deep that they touch the base construction and can be attached to it. Individual, smaller “floating” waves are possible.

Left: The eleven-meter-high “curtain” is meant to swing over the base. The opening is planned for fall 2017.



When designing, Burckhardt + Partner and tgs Architekten had movie theater curtains in mind.

SWITZERLAND

BILLOWING EMBROIDERY FABRIC

Multi family home “Central,” Einsiedeln

LOCATION: Hauptstrasse 22/24 CLIENT: private ARCHITECTS: Unger & Treina AG, Zurich

BUILDING PERIOD: 2013/14 GENERAL CONTRACTOR: Josef Diethelm, Freienbach

FAÇADE CONSTRUCTION: Beda Holzbau AG, Egg

At first glance, the “Central” house in Einsiedeln is confusing. It seems as though one is standing in front of a cut-open structure from whose interior, a greenish curtain billows in the wind. But in fact, the building has two faces: towards the street it displays a concrete façade, on the backside, a flowing, undulating, garment.

RAHEL HARTMANN SCHWEIZER The new “Central” house stands in a prominent spot in the heart of Einsiedeln, directly adjacent to the “Zwei Raben” culture and congress center, a former orphanage, poorhouse, and hospital from 1859 that was converted to an event center in 1977. The “Central” also conforms to the new conception of Dorfplatz, the village’s main square, which the community initiated in 2015: in accordance with the region’s overall policy, Einsiedeln hereby wants to upgrade the village center and make it more attractive. The architectural office Unger and Treina thus also understood its task for the “Central” as one of creating quality living spaces and attractive sales areas, and at the same time, accommodating the exposed situation in terms of urban development. The building thus defines itself as the pivotal point of the village square: the representative façade embraces a backside with an undulating layout. The architects emphasize the figure with bays, with which they accentuate the corner between Dorfplatz and the main street, Hauptstrasse. Serving as counterpart on the backside are terraces, which are carved into the curved geometry.

railings—represents the site’s sophisticated and sacral character. The other recalls the rural village character of days gone by.

Different interpretations

Originally, the architects attempted to walk the fine line between village and city by means of wooden shingles, which would have contrasted the representative urban front. But then the reference to rural tradition would have become overly didactic and hardly appropriate for the present day site. The idea of having the shingles designed in a modern material inspires various interpretations: from a turning outward of the interior space to a green façade and garden terracing through to a soft, flowing dress. The natural analogy arises through the choice of colors—a light grayish-blue, delicate mint green, and strong, shaded grayish green. An association with billowing embroidery fabric is evoked by the repetitive rhythm; which although seemingly random, is nonetheless based on a particular pattern within which the various colors are distributed.

Glamorous versus village character

The architects further emphasize the house’s two faces by organizing their layouts differently. On the façade towards the square are three top floors above a base, set over which is a recessed, fully glazed top floor. To highlight the seemingly random course of concave and convex curves of the back, the architects blurred the division of floors by offsetting the windows. They proceeded in a similar way with the materialization. The visible sides are carried out in concrete while the back is clad with Swisspearl small format. And there, too, the sense of the two faces is revealed. The one—refined by paintings in the bow front glazing and decorative balcony

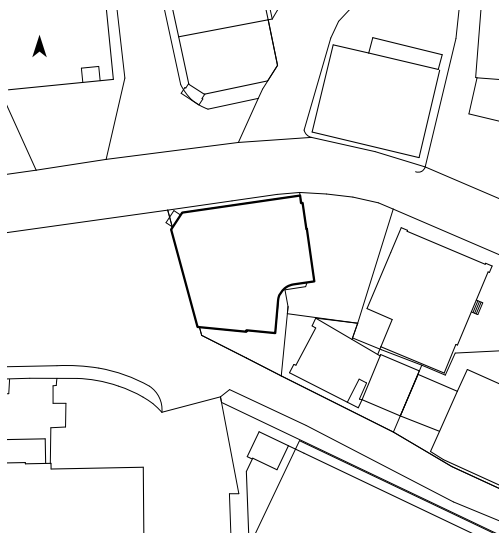



“The new building is conceived as a hub of the village square.”

Unger & Treina architects

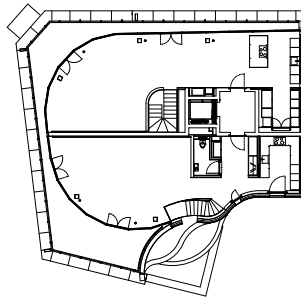

Attic floor

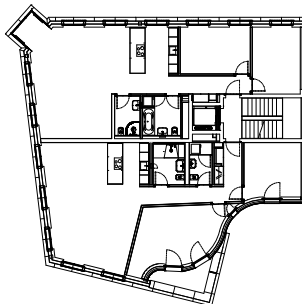

Second floor

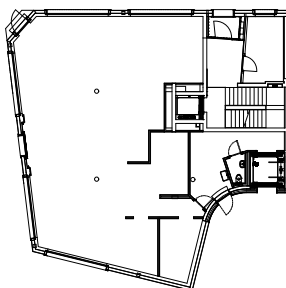

First floor 1:500

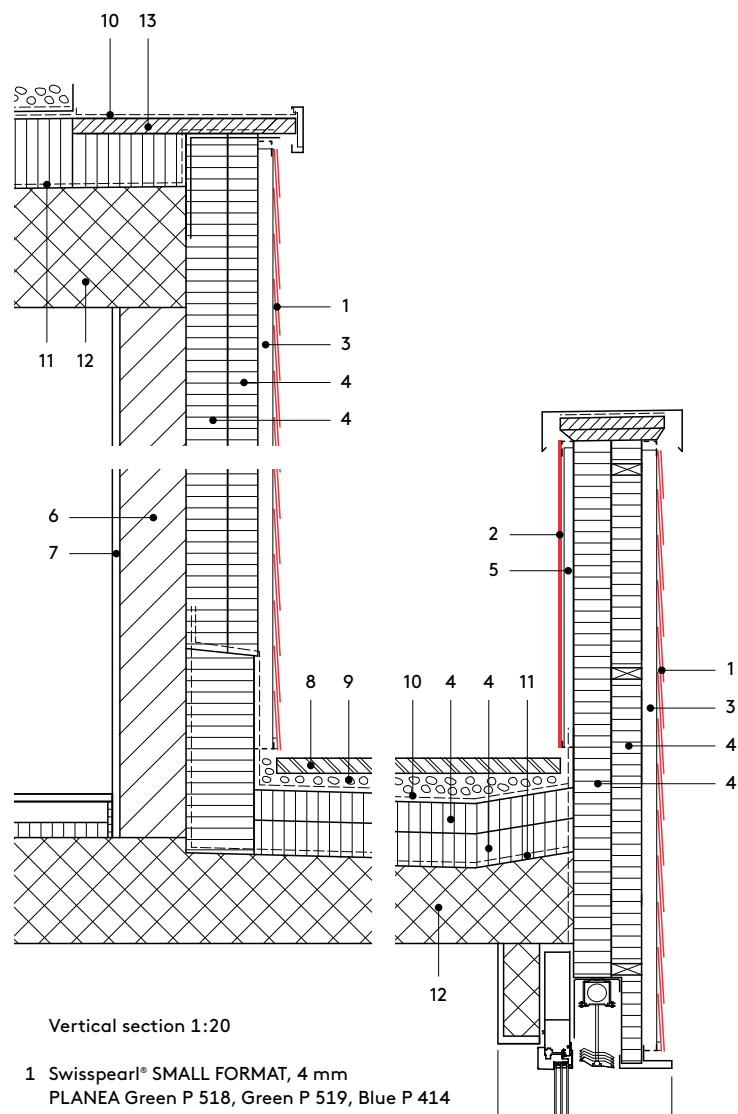

Vertical section 1:20

- 1 Swisspearl® SMALL FORMAT, 4 mm
PLANEA Green P 518, Green P 519, Blue P 414
- 2 Swisspearl® LARGO, 8 mm
- 3 ventilation cavity, vertical slats
- 4 thermal insulation
- 5 ventilation cavity, vertical slats with EPDM rubber
- 6 brickwork
- 7 plaster
- 8 tile flooring
- 9 grit
- 10 waterproofing
- 11 vapor retarder
- 12 concrete
- 13 wooden board

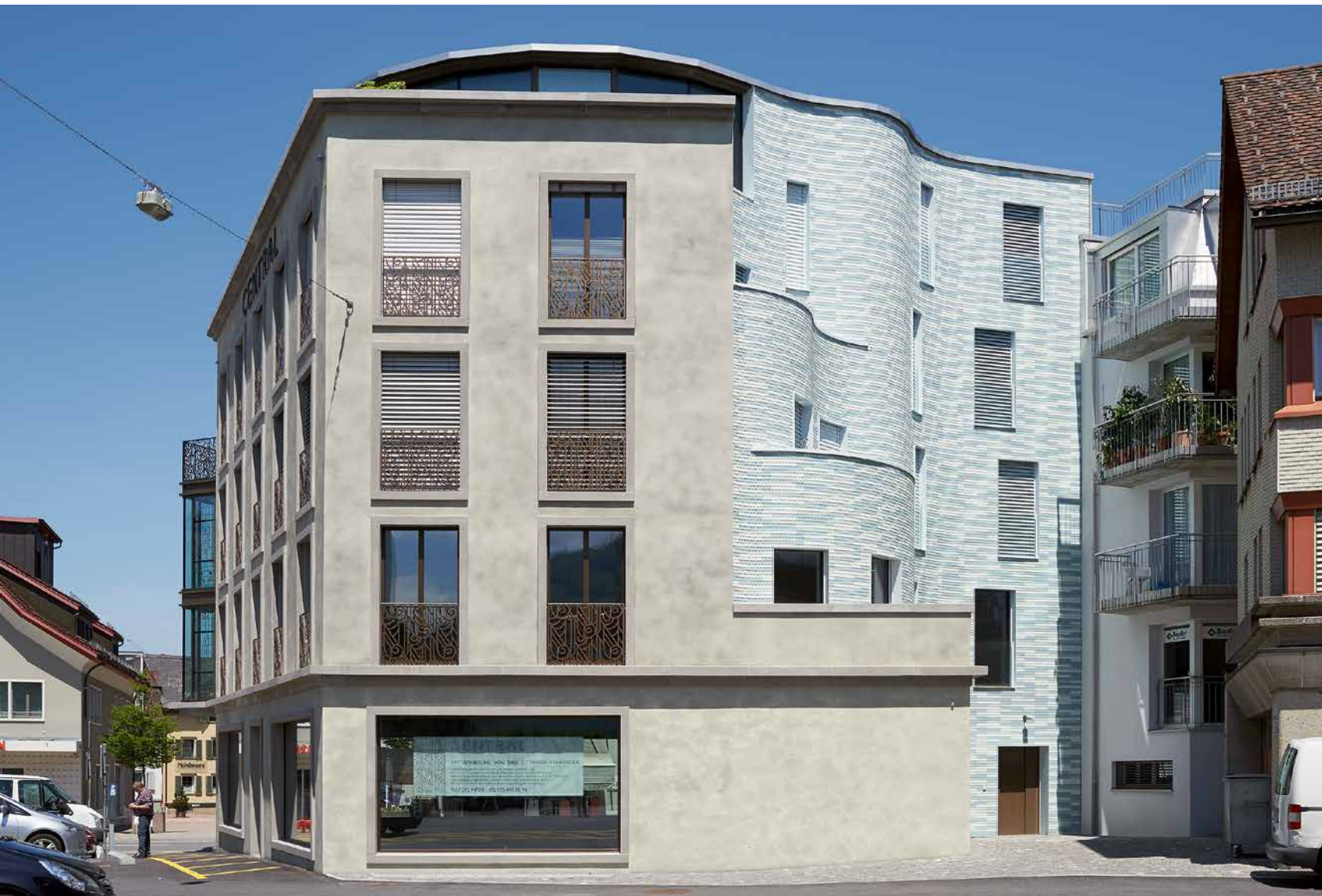

The seemingly randomly arranged green and blue tones of the façade shingles form a decorative pattern. The building bears two faces: a sophisticated one turned toward the city, and a rural-green one on the backside.

SWITZERLAND

DRUMLIN WITH POLYHEDRON

Single family home, Hirzel

LOCATION: Dorfstrasse 13 CLIENT Peter Dünki, Hirzel

ARCHITECTS: Christa Stutz & Benno Kohli, Wohlen BUILDING PERIOD: 2009/10

FAÇADE CONSTRUCTION: Roland Salm Fassadenbau AG, Schinznach-Dorf

Various factors affected the design of this single family home: The clients submitted their ideas for living and residing. The building authorities set guidelines for protection of the local architectural heritage. The architects thus shaped a multiply folded structure with a unique character, which does justice to both the surroundings and inner life.

MICHAEL HANAK The hilly landscape between Lake Zurich and Lake Zug is particularly beautiful. The elongated, oval hills once formed by glacial drift are called drumlins. On each hill is a tree. There, on the edge of a farming village, a married couple fulfilled their dream of a single family home. They didn't want a conventional house, but instead, one entirely unique in a contemporary architectural language. The architects Christa Stutz and Benno Kohli took the ideas and concepts of the clients, which emerged over the course of several conversations, and developed from them the design of the house with its unique outer shape.

According to Benno Kohli, "An advantage of the freestanding single family home is that all four cardinal points can be made tangible." Based on this realization, the architects viewed the building as a unit: all its sides should be designed and materialized equally. The roof, which is clearly visible from the driveway, is conceived as a fifth façade.

Roof as design theme

A few materials came into consideration for an equal treatment of the façades and roof. Shortly thereafter, the decision was made to use large-format, silver-gray fiber cement panels with reduced form, sheet metal closures. The architects had the fiber cement panels of varying dimensions installed in horizontal layers. The windows, also of various sizes—some flush fitting on the exterior, some attached inside—seem freely distributed following inner laws without taking into consideration the panel alignment.

Building regulations limited the house's form. The building authorities rejected a strong deviation from local custom. In the single-story residential zone, only low building heights are allowed, and platform roofs are prohibited. Additionally, the roof should be shingled, but not the façade. The archi-

itects thus elevated the roof form to become an underlying design theme. Various pitches and irregular geometries define the roof's appearance, as does a succinct structure added on as a central skylight, which flows seamlessly into the façade. The side façades are multiply buckled, and an incision in the northwest corner forms a courtyard. In this way, a uniformly enveloped, irregularly shaped structure arose.

On the one hand, the attractive landscape with the distant mountain peaks was taken as a theme, while on the other hand, it guaranteed orientation toward the evening sun. The large living space on the southeast side opens toward the impressive panorama with extensive, floor-to-ceiling glazing. By virtue of a ribbon window that is led down to the floor and around the corner, the eating area adjacent to the living space maintains a strong relationship to the protruding, northwest courtyard, which remains introverted and calm, surrounded by a retaining wall and planted with an orchard of beech trees. The eating area is at the center of the spatial relations: surrounded by the courtyard and directly below the skylight, it leads seamlessly into the living space and creates visual contact to the gallery on the upper floor.

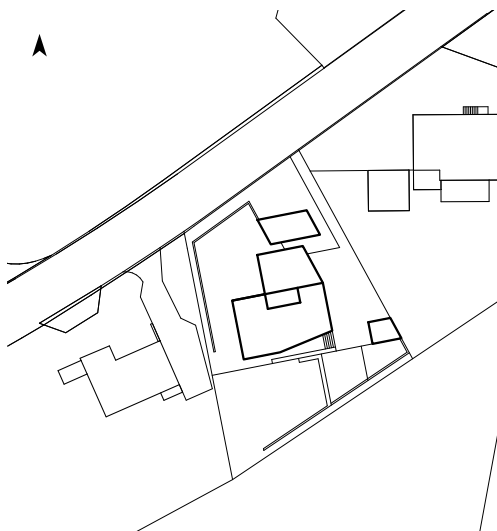





“The zoning and roof guidelines limited the design so greatly, that the roof as a theme became a fundamental idea.”

Christa Stutz, architect



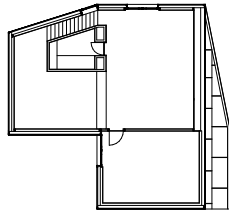

Upper floor

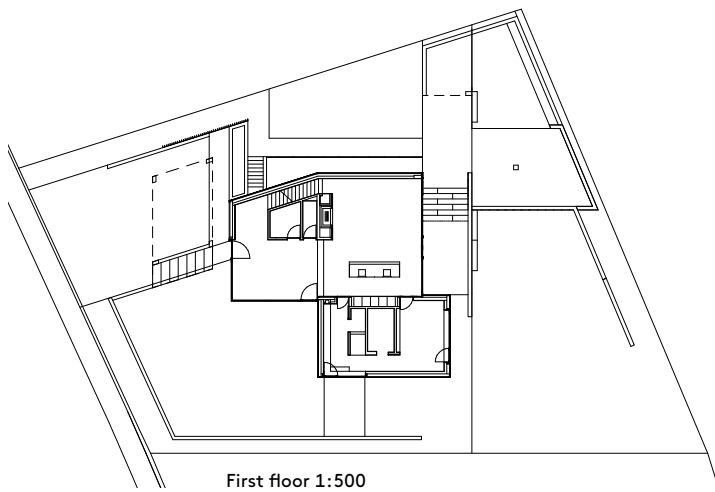
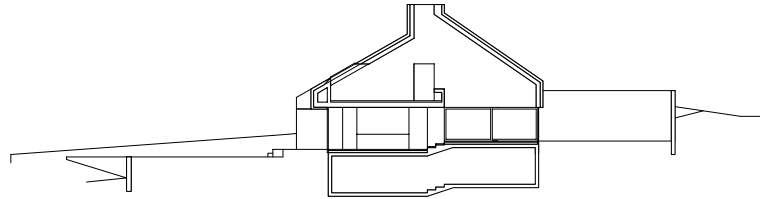

First floor 1:500

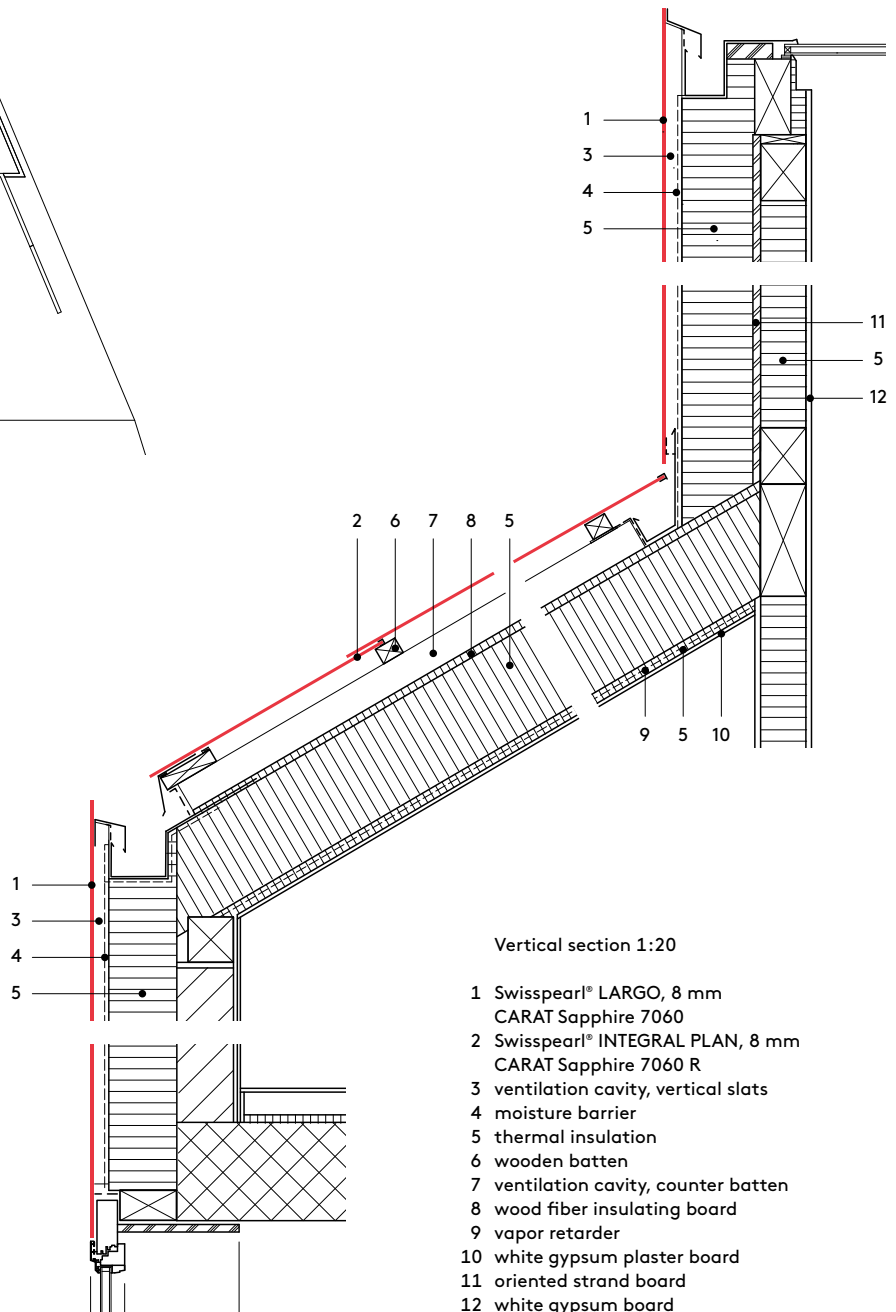

Vertical section 1:20

- 1 Swisspearl® LARGO, 8 mm
CARAT Sapphire 7060
- 2 Swisspearl® INTEGRAL PLAN, 8 mm
CARAT Sapphire 7060 R
- 3 ventilation cavity, vertical slats
- 4 moisture barrier
- 5 thermal insulation
- 6 wooden batten
- 7 ventilation cavity, counter batten
- 8 wood fiber insulating board
- 9 vapor retarder
- 10 white gypsum plaster board
- 11 oriented strand board
- 12 white gypsum board

Inside, too, materialization is simple and unpretentious: floors of dyed, cast anhydrite; walls plastered white, and all carpentry work done with cherry tree wood.





ITALY

RECLINING MONOLITH

Villa D'Orsi, Casciago, Varese

LOCATION: Via A. Manzoni 4 CLIENT: Raffaele D'Orsi, Casciago

ARCHITECTS: Studio di Architettura Franco Segre, Varese (PROJECT ARCHITECT: Elisa Campiglio) BUILDING PERIOD: 2014/15

FAÇADE CONSTRUCTION: Lave snc di Alfio Luzzana e Fiori Veruska, Villa di Serio

During the rebuilding of a villa in northern Italy, the architects carried out two separate structural interventions: for one, they carefully restored the 1930s structure, for another, they augmented an existing annex and covered it with a uniform façade of dark Swisspearl panels. The annex's freely distributed openings are a deliberate contrast to the villa's strictly organized layout.

PATRICK ZAMARIÀN Villa D'Orsi, which was built in the 1930s, is found in the northern Italian community of Casciago near the Swiss border. Fascist Italy's *Heimatstil* (Homeland style) differed only negligibly from the contemporaneous building styles of the European surroundings—other than the fact that many Italian architects of this era composed the façades symmetrically and furnished them with romantically historicizing typologies, such as rusticated corner pilaster strips and arched windows with interstitial columns. The local architectural office Franco Segre took great care in restoring these and other decorative elements, such as the wood cladding and the meander at the level of the windowsill. The exterior walls' plastering in muted earthy tones harmonizes with the bright gray tones of the façade details, while dark-painted metal elements accentuate the façade. The architects replaced the existing roof covering with dark gray cement shingles and upgraded the roof with photovoltaic panels.

The private premises are on the upper floor. The house owner's office and rooms for guests and children are situated in the villa while the new main bedroom fills the entire annex, thereby one-third of the floor space.

Differentiating new and old

Although the villa and annex form one unit functionally, the architects decided to separate the two parts of the building and distinguish them in terms of design by means of a twenty-centimeter-wide polished, stainless steel band. In contrast to the classically formulated main building, the annex is a freely shaped structure whose irregular openings and faceted shell of anthracite fiber cement panels deliberately deviate from the strict orthogonality of the adjacent façade surfaces. The architects let themselves be guided in their design by the idea of a multiply folded monolith reclining on the existing villa. The height difference and the slight recession of the façade emphasize this implicit hierarchical relationship, as does the monochromatic, dark color, which allows the annex to fall back in the shadows of the main building, as it were.

Augmenting and enhancing the annex

Due to the villa's symmetrical layout, uniform, relatively small individual spaces line up alongside one another. The solid construction makes it practically impossible to break through this layout. In order to introduce contemporary, open living forms in the villa, a single-story annex was added onto the west side already in the 1980s, which the architects now augmented and enhanced. On the ground floor, they added an extensive eat-in kitchen, which supplements the existing, circuitously arranged living and common spaces and offers direct access to the garden.

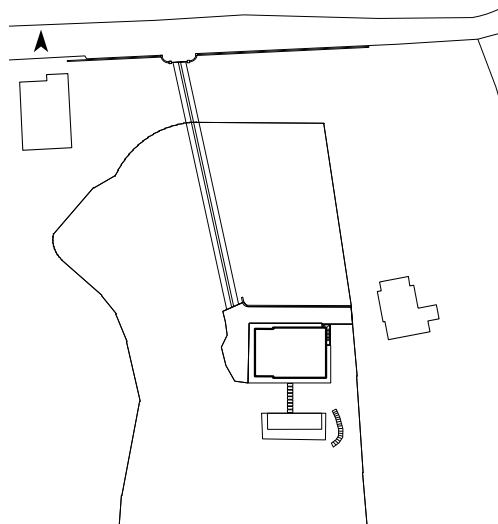

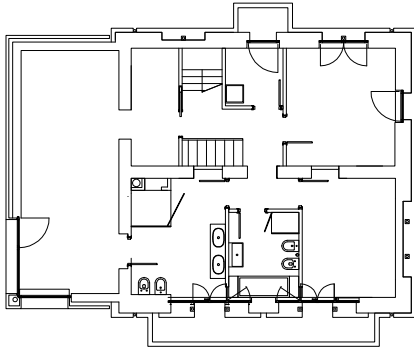

Upper floor

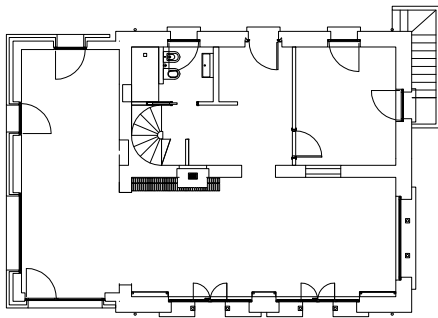

First floor 1:200

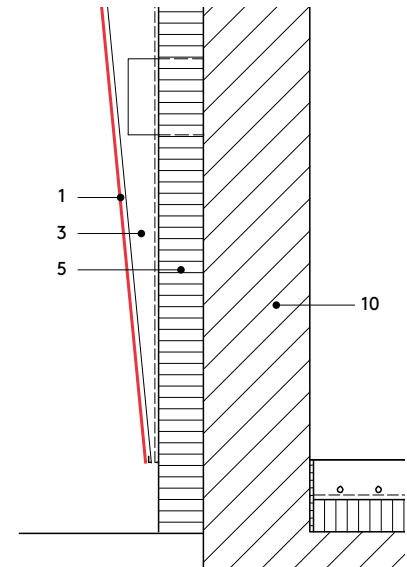
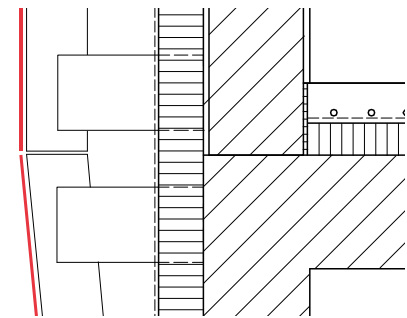
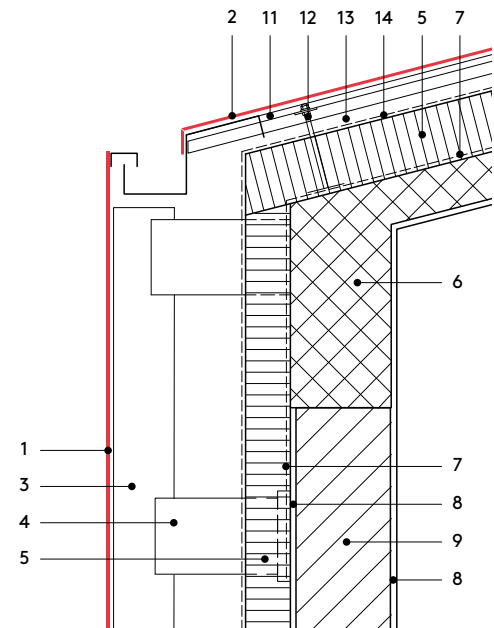

“From a compositional perspective, our idea comprised handling the new section with a different language, and thereby upgrading the proportions and symmetries of the main building.”

Studio di Architettura Franco Segre

Vertical section 1:20

- 1 Swisspearl® LARGO, 12 mm
CARAT Black Opal 7020
- 2 Swisspearl® LARGO, 12 mm
CARAT Black Opal 7020 R
- 3 ventilation cavity, vertical sub framing
- 4 bracket
- 5 thermal insulation, mineral wool
- 6 concrete
- 7 vapor retarder
- 8 plaster
- 9 brickwork
- 10 existing brickwork
- 11 corrugated metal decking
- 12 bracket
- 13 ventilation cavity
- 14 waterproofing

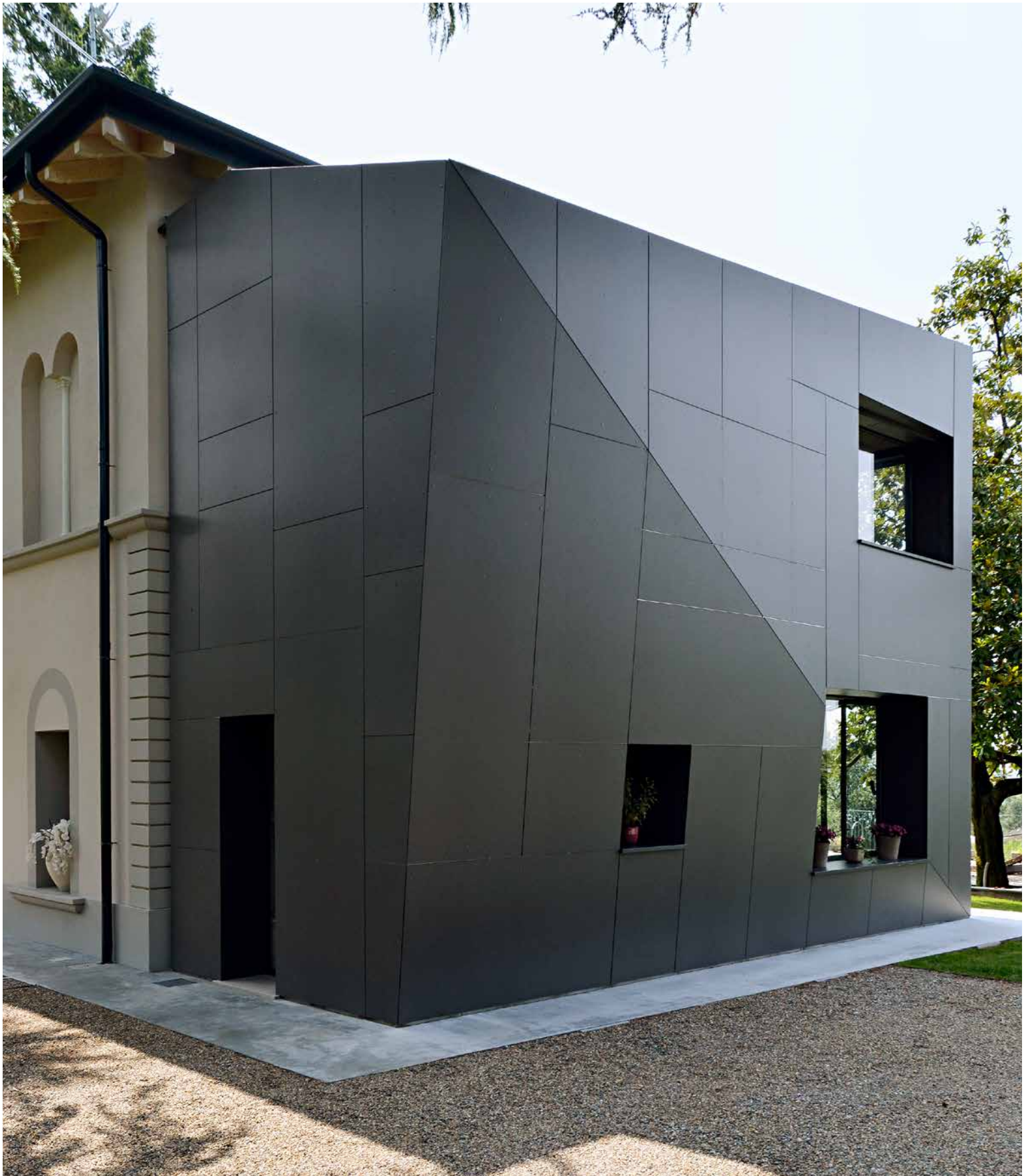



SKREIN

AUSTRIA

DIAMONDS ON A FLYING CARPET

Skrein Jewelry Store, Vienna

LOCATION: Spiegelgasse 5 CLIENT: Alexander Skrein, Vienna

ARCHITECT: Mathis Barz, Vienna BUILDING PERIOD: 2012

The notion of combining fiber cement panels with precious jewels might seem incongruous at first, but Skrein jewelry demonstrates how the substance can be combined with contrasting materials, in this case precious metals and jewels, in exciting and novel ways.

ANNA ROOS In order to sell high end, luxury products, companies have to lure customers with superior design and exclusive materials. Display windows and shopfronts vie to catch the eye of passersby. Situated in one of the most exclusive areas of Vienna, is the jewelry atelier of Alexander Skrein. At the beginning of 2012, Skrein approached architect Mathis Barz—with whom he had previously collaborated—with the concept of remodeling his shop using concrete elements and reconceiving the previous interior color palette of red and orange tones in a more discreet palette of browns and grays. Initially Barz was rather skeptical about the concept of using such a hard, brutal material in combination with the delicate jewelry, but then he thought of the possibility of using fiber cement—a material that combines the durability and malleability of concrete with the lightness and slenderness of composite materials—and recognized the potential of juxtaposing Skrein's designs with Swisspearl surfaces. To begin with, he had Swisspearl carry out experiments to test the boundaries of the plasticity and malleability of their panels. As soon as the panels emerge from the machine in their damp state, they are cut to the necessary dimension. They are then laid onto a three-dimensional molded form over night until they solidify. After two weeks, the material hardens to a degree where it can be re-treated and sealed. The initial prototypes were so successful that Skrein decided to use the material for all the displays throughout the shop.

A powerful combination

The composite material has been molded to resemble fabric. For the “soft look,” as Barz calls it, each element is individually finished

by hand. Thus each element is a unique piece with its own character, rather like the hand-crafted jewelry on display. The various possibilities of cutting and finishing the edges of the material have been exploited: cutting the thickness cleanly at right angles or tearing it to give it a rough, jagged edge. The manner in which the material folds over the horizontal display surfaces is like a tablecloth, the texture like thick woolen felt. The display surfaces gently undulate, forming a mini landscape of sorts in which the precious necklaces, rings, and bracelets are presented to beholders. Barz uses the metaphor of a flying carpet to describe his design and says the displays “combine the archaic force of fiber cement with the poetry of a flying carpet.” Each window display has been designed as a mini stage on which the “main characters”—the lustrous jewelry—are under the spotlight.

Barz has juxtaposed two dissimilar materials with contrasting surface textures: on one hand, the muted, matte gray fiber cement panels customarily utilized as exterior façade cladding and on the other, the luster of the precious metal jewelry, thus accentuating the delicately crafted gold and silver pieces and highlighting their beauty. Barz rightfully calls it a “powerful combination” and is proud to use the material in this innovative context, making it, as he says, “presentable.”



“The ‘soft look’ combines the archaic force of fiber cement with the poetry of a flying carpet.”

Mathis Barz, architect



KNOW-HOW

It began in the 1950s with Willy Guhl: The designer was fascinated by the composition of fiber cement. Today, his Loop chair is considered a classic. Collaborations with more than twenty product designers followed from it. Their creations continually bring a fresh breeze into the firm.

In the production hall, no machines can be seen far and wide: everything is made by hand. Designers and hand molders work together in their search for perfection. Those who want to develop new products must understand the material and its qualities. Sketches are followed by talks about feasibility and market opportunities. A prototype emerges on the basis of an initial basic form, and is then subjected to critique. In most cases our hand molders provide the decisive impulse for improvements. Finding a suitable form often takes several weeks. At the same time, two worlds must come together: that of the designers, and that of producers.

Once decisions about market prices, production volumes, and marketing activities have been made, actual serial production begins. The molding occurs exclusively by hand, piece by piece. Our staff cuts out the shape based on a template, and embeds it in a positive or negative form. Every now and then, they pound the material steadily. Two days later, one can see if the work was a success. In the end, every product is examined and then numbered and signed by the designer—after all, they are handmade unique pieces!

Facts and figures

- Roughly 35,000 hand molded vessels and designer objects are produced each year.
- 12 hand molders work in the molding shop in Payerne.
- 1 single product can be manufactured per form, per day.



Marcello Trabucco,
Manager Garden & Design,
Swisspearl

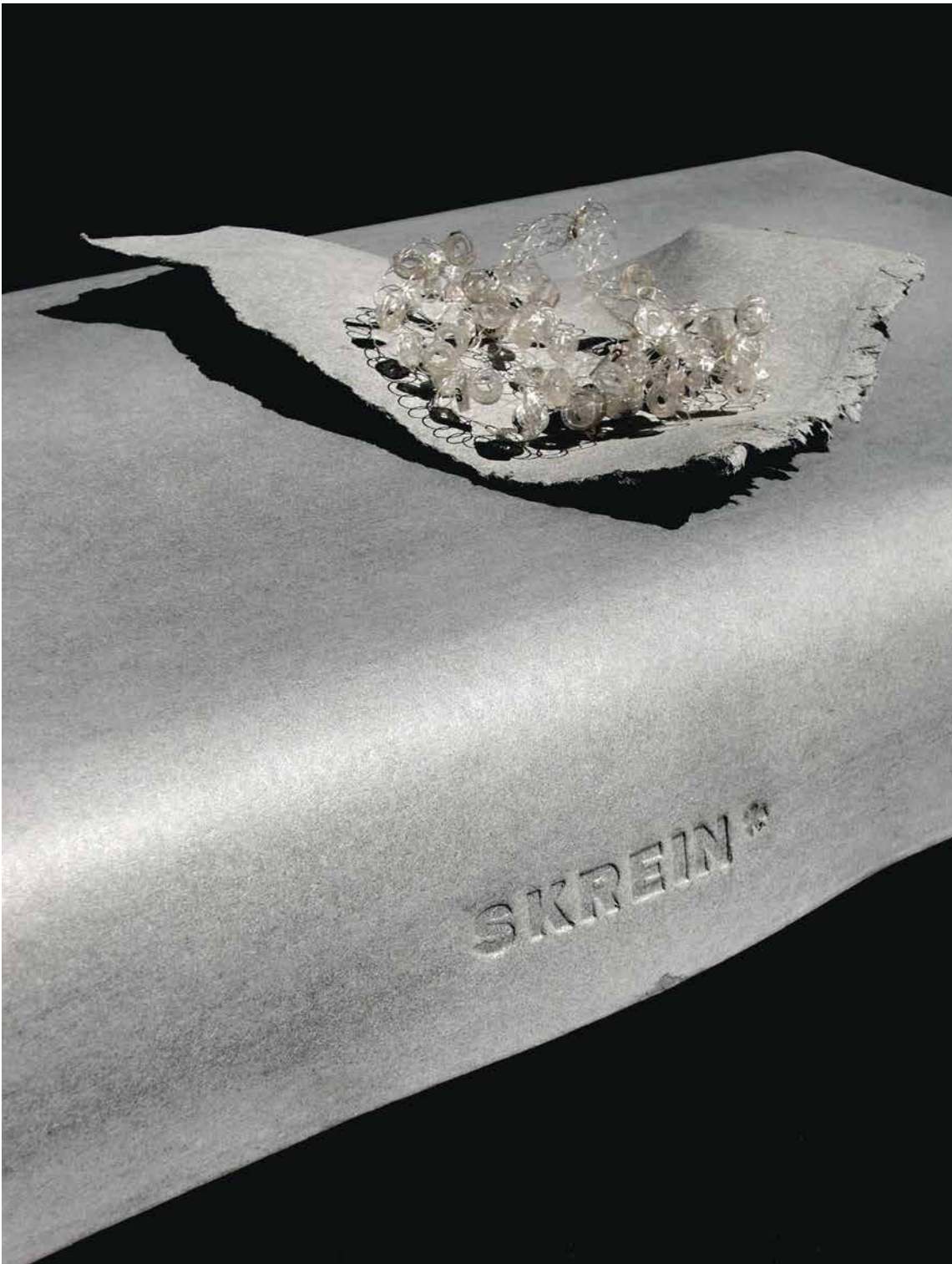

Some of the exhibition surfaces are precisely cut, others seem torn out at the corners, which lends them a rough chic look.

SPECIAL SELECTION

INFLATED PLACE HOLDER

A little white house prances on the green meadow; its sidewalls bulge slightly outward. Via a tube, a ventilator steadily furnishes it with the air that lends it volume and constancy. The architects Simon Durand and Gabriel Soulard have created a three-dimensional "place holder" with this six-by-six-by-six-meter lightweight construction. The idea is to make it easier for clients to imagine a property in a developed state. Architects are fascinated by the lightness of inflatable objects says Urs Meier, owner of Luft & Laune, "And that certain structural laws, such as statics, do not apply to them." With his firm for inflatable objects, he often works for the creative economy; in addition to architects, his clients also include several artists and theater people. The lightweight material can be easily built up to a volume or, better yet, blown up. The effect that it unfurls, however, is usually quite great.

Meier and his team first compose each object as a three-dimensional form and determine the seams in CAD to generate an optimal cutting pattern. Based on this data, the plotter custom cuts the individual plastic sheeting parts, which Meier and his staff sew or solder together to an object. As Meier explains, "Amorphous objects are most suitable" as the air pressure inside is equally distributed. Concave forms are only conditionally possible, as every recess requires a pull point or a surface. "We do not like to make flat surfaces because they rarely turn out well," says Meier. For him, the most beautiful objects are those that make a great impact with little effort. Such as the "bubble bike" for raumlabor Berlin: a meeting room for a conference that arises from a few tethers, a lot of air, and a sculptural skin whose parts Luft & Laune joined together with adhesive tape. (me)



"Bubble bike" by raumlabor Berlin.



Architects Simon Durand and Gabriel Soulard created a three-dimensional "place holder," Lausanne / Alençon.

PRODUCT DESIGN

SQUARING THE TABLE

For the architect, designer, and artist Stefan Sieboth, drawing by hand, but following strict geometric rules is no contradiction. He designed a table based on a concept for the form, and selected fiber cement for the legs to produce the wave shape he had in mind. The result is a structural art work.

MICHAEL HANAK The table is meant to appear charged and visually light, says Stefan Sieboth. At the start was an idea for a form: a square that moves, turning, through the room. Sieboth created various sculptures related to this idea, among others, a seven-meter-high, chrome-steel column that he erected in his garden. He later combined the form idea with a table design and developed it further: starting from a table

with four oblique legs, Sieboth conceived a sculptural table frame. He furnished the square base area with four round protrusions on the corners, like a windmill, allowing the surface to complete a 45-degree turn from the floor to the height of the table top. To realize the table design, the designer first thought of chrome, which he sliced a number of times for better formability. However, the effort was too great and costs too high. He then remembered Willy Guhl's legendary garden furniture of fiber cement. Sieboth had two old Loop chairs in his garden. Like Guhl, Sieboth utilized fiber cement's formability, thereby arriving at a final solution for the silver wave table. The material takes on the desired form in a negative mold. In the end, a round or oval glass top is placed on the sculpturally waved base.

Silver wave table

DESIGNER
Stefan Sieboth

YEAR OF DESIGN
2013

DIMENSIONS
ca. 70 × 70 × 71 cm

MATERIAL TABLE TOP
float glass, 12 mm, round 140 cm diameter; or oval 100 × 160 cm

MATERIAL TABLE FRAME
fiber cement, 8 mm

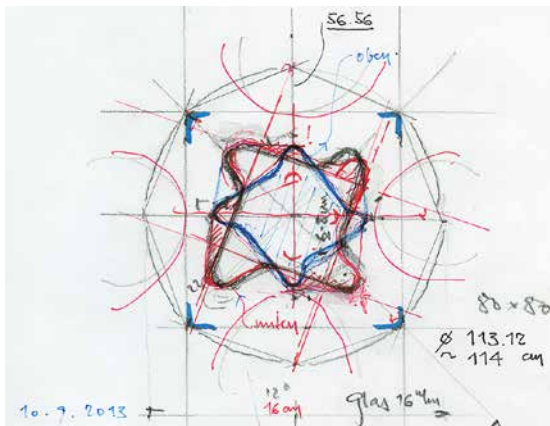

Due to its folding and turning, the table base is stable yet nonetheless appears light. Through its design, the table attains an object-like quality. It can easily be assembled outdoors—and goes well with Willy Guhl's early designs.

The architect, product designer, and artist Stefan Sieboth will turn eighty this year. His oeuvre includes clearly structured buildings, unique furniture pieces, and artworks based on geometric regularity. Since the founding of his office for architecture and industrial design in 1959, he has aspired to realizations of functional requirements in an architecture that has great utility and experiential value. Parallel to his architectural work, he has consistently created furniture and explored the further development of concrete art in its three dimensionality.

Towards the end of his training as an architect, Sieboth found influential role models. At the International Building Exhibition 1957 in Berlin he was impressed by Alvar Aalto and his casual treatment of dissolved geometries. Later on he was fascinated by Oscar Niemeyer who designed his studio over the Copacabana in Rio de Janeiro as a fantastical wave-shaped form. Asked about the difference between architecture, sculpture, and object design, Sieboth points out that scale is decisive: the form of the table in his garden cannot be transferred to a high rise in a city.

**Garden sculpture:
elegant twists for
a table.**





The Swisspearl exhibition stands at the AIA 2016 in Philadelphia (top), at the AIA 2014 in Chicago, and the AIA 2015 in Atlanta (right).

In 2017, the AIA Congress will take place in Orlando, Florida, from April 27th to 29th.



AIA ARCHITECTURE CONVENTION

SHOWTOWN PHILADELPHIA

The American Institute of Architects (AIA) convention, held in conjunction with the institute's annual business meeting, is hailed as *the* architecture and design event of the year in the U.S., attended by thousands of architects, designers, business people, industry representatives, and offering seminars, tours, events, and lectures by leading lights in their field.

ANNA ROOS This year's annual AIA convention was held in Philadelphia, a city rich in historic buildings, public squares, vibrant markets, and verdant parks. Drawn by Philadelphia's architectural wealth and its accessibility by public transport, 2016's convention hosted a record number of participants. With the sheer amount of events, lectures, parties, and tours on offer it is no wonder Christopher Gribbs, managing director of the convention, refers to the coordination of the annual event as a "Herculean effort." Held under the grandiose archway of an old station building in downtown Philadelphia, more than 720 exhibitors showcased their building products and technology. Although the primary target audience is AIA members—professional architects—allied professionals from related fields, including engineers, interior designers, and urban planners also make up around two-thirds of attendees: and 17,800 attendees were the exhibitors themselves.

Cruising the trade floor and learning what new products are available and having the opportunity to network are significant reasons for attending. Various themes are explored throughout the expo, ranging from business management, ADA compliance (Ameri-

cans with Disabilities' Act), LEED green building, and health issues. According to Gribbs, the convention's aim is to reflect the diverse interest of architects and acknowledge the broad spectrum from art to business and technology to construction in a manner that is stimulating and enticing for the highly discerning audience of architects.

Due to its prominence in the U.S. architectural calendar, and the fact that the U.S. is Swisspearl's second largest market, the event is an important platform for the company to showcase their products. Robert Wirichs, Head of Business Unit Export at Swisspearl, commented that the expo has continually improved in both scale and quality. To reflect this trend, Swisspearl's stand has increasingly grown and become more sophisticated. Roger Castro from the design studio Monzon in Barcelona was commissioned to design the stand in 2016. Castro's concept was to present Swisspearl products in the most dynamic, interactive manner possible using three distinct elements: a central storage unit, a corner wall element, and a corner element with rotating boxes displaying images, detail drawings, and information about Swisspearl panels. The display presented the wide palette of colors offered by Swisspearl—including examples of the hundreds of bespoke colors commissioned by architects—the various scales of the panels ranging from large-scale, to far smaller linear elements, and modular overlapping panels. Apparently, architects were especially interested in the high-quality perforated panels.

The AIA's aim is for those who attend to "leave inspired, connected, and empowered" and to be given "practical tools to help achieve goals" so that they return to their respective work places "invigorated by new ideas, connected to new contacts, and motivated to tackle challenges in new ways." Robert Wirichs is convinced that having the opportunity to tap into this significant event in the U.S. makes Swisspearl's investment worthwhile.



Publisher

CH-8867 Niederurnen
Switzerland
phone +41 (0)55 617 11 60
info@swisspearl.com
www.swisspearl.com

The internationally distributed magazine *Swisspearl Architecture* sets Swisspearl fiber cement products within a contemporary architectural context.

Advisory board

Michèle Rüegg Hormes,
division manager communication,
Dept. of Architecture, ETH Zurich
Martin Tschanz, docent ZHAW

Editorial committee

Michael Hanak
Hans-Jörg Kasper
Martina Kast
Marco Pappi
Jürg Schönenberger
Yasmin Willi
Robert Wirichs

Editor

Michael Hanak, Zurich

Editing

Marion Elmer, Zurich

Translation

Lisa Rosenblatt, Vienna

Design

Bernet & Schönenberger, Zurich

Detail plans

Deck 4 GmbH, Zurich

Printing company

Galledia AG, Flawil

Print run

20,000

Typeface

Brown Pro, Mercury Text

English edition

ISSN 1661-3260

Authors

Michael Hanak is a Zurich-based historian specialized in art and architecture. He has a preference for contemporary architectural history and the current handling of it.

Rahel Hartmann Schweizer is a historian specializing in art and architecture. After having worked as an editor and on a dissertation on Otto Kolb, she now writes about the interdisciplinarity of architecture, art, and engineering.

Anna Roos is a Bern-based architect. She writes about current architectural events and works as a translator and editor. Her book *Swiss Sensibility: The Culture of Architecture in Switzerland* was published by DAAB Publishers in Summer 2016.

Patrick Zamarian is a freelance writer and translator. For his PhD thesis at the University of Liverpool, his focus is on British postwar architecture.

Photos

C1: Gramazio Kohler Research, ETH Zurich
C2: Oliver Dubuis/Pro Helvetia, Zurich
C3: Martin Stollenwerk, Zurich
C4: Jürg Zimmermann, Zurich

p. 1 top: Gramazio Kohler Research, ETH Zurich

p. 1 middle: Hertha Hurnaus, Vienna
p. 1 bottom: Jürg Zimmermann, Zurich

p. 2: Alamy, Abingdon

p. 4 top: Ulf Böttcher, Potsdam

p. 4 middle left: Wikicommon

p. 4 middle right and bottom:

Alamy, Abingdon

pp. 6–15: Gramazio Kohler

Research, ETH Zurich

pp. 16–19: Duccio Malagamba,

Barcelona, and Stefan Berger,

Eternit, Vöcklabruck

pp. 20–25: Lorcan Doherty, Derry

pp. 27–29: Anna B. Gregorczyk,

Poznan

pp. 30–37: Hertha Hurnaus, Vienna

p. 38: Martin Bähler, Näfels

p. 39 top: Schweizer Baumuster-

Centrale, Zurich

p. 39 middle and bottom: Burck-

hardt + Partner, Basel

pp. 41–47: Jürg Zimmermann,

Zurich

pp. 49: Reinhard Zimmermann,

Baar

pp. 50–53: Francesca Mandelli

D'Agostini

pp. 54–57: Monika Nguyen, Vienna

p. 58: raumlabor, Berlin

p. 59: Gabriel Soulard, Alençon

pp. 60/61: Stefan Sieboth, Deren-

dingen

p. 62 top: David Stutts, Philadelphia

p. 62 bottom: Warren Perlstein,

Chicago

p. 63: Reis Birdwhistell, Atlanta

Legal notes

Texts, images, photos and graphic work in this publication are protected by copyright and other intellectual property rights. Rights to the texts are owned by the writers in all cases. The contents of this publication may not be copied, distributed, altered or made available to third parties for commercial purposes. Further, some pages include images the copyrights of which are owned by third parties.

This publication has been assembled with the greatest possible care. Nevertheless, the publisher cannot guarantee freedom from error and the complete accuracy of the information it contains. The plans have been kindly provided by the architects. The detailed plans have been reworked for greater legibility; the editors are not able to guarantee their accuracy.





Single family house in Hirzel, Switzerland, 2009/10, Christa Stutz & Benno Kohli, Wohlen

FREE FORMS

A polyhedron is enthroned on a hill. A monolith leans on a villa. A façade billows like a curtain in the wind. This edition of *Swisspearl Architecture* tracks down the ideas and motivations behind unconventional building forms and façade structures. It presents individually shaped structures built to different scales and for various purposes. And it shows three-dimensional façade cladding designed by architects and designers, and further developed by the Swisspearl staff.